

# BOXER-6615

---

Fanless Embedded Box PC

User's Manual 2<sup>nd</sup> Ed

## Copyright Notice

---

This document is copyrighted, 2017. All rights are reserved. The original manufacturer reserves the right to make improvements to the products described in this manual at any time without notice.

No part of this manual may be reproduced, copied, translated, or transmitted in any form or by any means without the prior written permission of the original manufacturer. Information provided in this manual is intended to be accurate and reliable. However, the original manufacturer assumes no responsibility for its use, or for any infringements upon the rights of third parties that may result from its use.

The material in this document is for product information only and is subject to change without notice. While reasonable efforts have been made in the preparation of this document to assure its accuracy, AAEMON assumes no liabilities resulting from errors or omissions in this document, or from the use of the information contained herein.

AAEMON reserves the right to make changes in the product design without notice to its users.

## Acknowledgement

---

All other products' name or trademarks are properties of their respective owners.

- Microsoft Windows® is a registered trademark of Microsoft Corp.
- Intel®, Platiun®, Celeron®, and Xeon® are registered trademarks of Intel Corporation
- Atom™ is a trademark of Intel Corporation
- ITE is a trademark of Integrated Technology Express, Inc.
- IBM, PC/AT, PS/2, and VGA are trademarks of International Business Machines Corporation.

All other product names or trademarks are properties of their respective owners.

## Packing List

---

Before setting up your product, please make sure the following items have been shipped:

Item	Quantity
● BOXER-6615	1
● Wallmount bracket	2
● Screw Package	1
● Phoenix power connector (A2M)	1
● Product DVD with User's Manual (in pdf) and drivers	1

If any of these items are missing or damaged, please contact your distributor or sales representative immediately.

## About this Document

---

This User's Manual contains all the essential information, such as detailed descriptions and explanations on the product's hardware and software features (if any), its specifications, dimensions, jumper/connector settings/definitions, and driver installation instructions (if any), to facilitate users in setting up their product.

Users may refer to the [AAEON.com](http://AAEON.com) for the latest version of this document.

## Safety Precautions

---

Please read the following safety instructions carefully. It is advised that you keep this manual for future references

1. All cautions and warnings on the device should be noted.
2. Make sure the power source matches the power rating of the device.
3. Position the power cord so that people cannot step on it. Do not place anything over the power cord.
4. Always completely disconnect the power before working on the system's hardware.
5. No connections should be made when the system is powered as a sudden rush of power may damage sensitive electronic components.
6. If the device is not to be used for a long time, disconnect it from the power supply to avoid damage by transient over-voltage.
7. Always disconnect this device from any power supply before cleaning.
8. While cleaning, use a damp cloth instead of liquid or spray detergents.
9. Make sure the device is installed near a power outlet and is easily accessible.
10. Keep this device away from humidity.
11. Place the device on a solid surface during installation to prevent falls.
12. Do not cover the openings on the device to ensure optimal heat dissipation.
13. Watch out for high temperatures when the system is running.
14. Do not touch the heat sink or heat spreader when the system is running
15. Never pour any liquid into the openings. This could cause fire or electric shock.
16. As most electronic components are sensitive to static electrical charge, be sure to ground yourself to prevent static charge when installing the internal components. Use a grounding wrist strap and contain all electronic components in any static-shielded containers.

17. If any of the following situations arises, please contact our service personnel:
  - i. Damaged power cord or plug
  - ii. Liquid intrusion to the device
  - iii. Exposure to moisture
  - iv. Device is not working as expected or in a manner as described in this manual
  - v. The device is dropped or damaged
  - vi. Any obvious signs of damage displayed on the device
18. Do not leave this device in an uncontrolled environment with temperatures beyond the device's permitted storage temperatures (see chapter 1) to prevent damage.
19. Do NOT disassemble the motherboard so as not to damage the system or void your warranty.
20. If the thermal pad had been damaged, please contact AAEON's salesperson to purchase a new one. Do NOT use those of other brands.
21. The Hex Cylinder Coppers on the front panel are not removable.
22. Repeatedly assemble and disassemble the system may cause damages to the exterior paint and surface and screw holes.
23. Use the right size screwdriver.
24. Use the screwdriver correctly to remove screws from the system.

## FCC Statement

---

### **Warning!**



This device complies with Part 15 FCC Rules. Operation is subject to the following two conditions: (1) this device may not cause harmful interference, and (2) this device must accept any interference received including interference that may cause undesired operation.

### **Caution:**

*There is a danger of explosion if the battery is incorrectly replaced. Replace only with the same or equivalent type recommended by the manufacturer. Dispose of used batteries according to the manufacturer's instructions and your local government's recycling or disposal directives.*

### **Attention:**

*Il y a un risque d'explosion si la batterie est remplacée de façon incorrecte. Ne la remplacer qu'avec le même modèle ou équivalent recommandé par le constructeur. Recycler les batteries usées en accord avec les instructions du fabricant et les directives gouvernementales de recyclage.*



## China RoHS Requirements (CN)

产品中有毒有害物质或元素名称及含量

AAEON Embedded Box PC/ Industrial System

部件名称	有毒有害物质或元素					
	铅 (Pb)	汞 (Hg)	镉 (Cd)	六价铬 (Cr(VI))	多溴联苯 (PBB)	多溴二苯醚 (PBDE)
印刷电路板 及其电子组件	○	○	○	○	○	○
外部信号 连接器及线材	○	○	○	○	○	○
外壳	○	○	○	○	○	○
中央处理器 与内存	○	○	○	○	○	○
硬盘	○	○	○	○	○	○
电源	○	○	○	○	○	○

○: 表示该有毒有害物质在该部件所有均质材料中的含量均在 SJ/T 11363-2006 标准规定的限量要求以下。

X: 表示该有毒有害物质至少在该部件的某一均质材料中的含量超出 SJ/T 11363-2006 标准规定的限量要求。

备注:  
一、此产品所标示之环保使用期限, 系指在一般正常使用状况下。  
二、上述部件物质中央处理器、内存、硬盘、电源为选购品。

## China RoHS Requirement (EN)

Poisonous or Hazardous Substances or Elements in Products  
 AAEON Embedded Box PC/ Industrial System

Component	Poisonous or Hazardous Substances or Elements					
	Lead (Pb)	Mercury (Hg)	Cadmium (Cd)	Hexavalent Chromium (Cr(VI))	Polybrominated Biphenyls (PBB)	Polybrominated Diphenyl Ethers (PBDE)
PCB & Other Components	○	○	○	○	○	○
Wires & Connectors for External Connections	○	○	○	○	○	○
Chassis	○	○	○	○	○	○
CPU & RAM	○	○	○	○	○	○
Hard Disk	○	○	○	○	○	○
PSU	○	○	○	○	○	○
<p>O: The quantity of poisonous or hazardous substances or elements found in each of the component's parts is below the SJ/T 11363-2006-stipulated requirement.</p> <p>X: The quantity of poisonous or hazardous substances or elements found in at least one of the component's parts is beyond the SJ/T 11363-2006-stipulated requirement.</p> <p><b>Note: The Environment Friendly Use Period as labeled on this product is applicable under normal usage only</b></p>						

# Table of Contents

---

<b>Chapter 1 - Product Specifications .....</b>	<b>1</b>
1.1 Specifications.....	2
<b>Chapter 2 – Hardware Information .....</b>	<b>4</b>
2.1 Dimensions .....	5
2.2 Jumpers and Connectors .....	7
2.3 I/O Location .....	9
2.4 Block Diagram.....	10
2.5 List of Jumpers .....	11
2.5.1 COM3 Function Selection (JP2) .....	11
2.5.2 COM2 Function Selection (JP5) .....	11
2.5.3 Auto Power Button Enable/Disable Selection (JP12) .....	12
2.5.4 Clear CMOS Jumper (JP15).....	12
2.6 List of Connectors .....	13
2.6.1 VGA Port.....	14
2.6.2 DC-IN .....	14
2.6.3 HDMI Port .....	14
2.6.4 USB 3.0 Port.....	15
2.6.5 USB 2.0 Port.....	16
2.6.6 LAN (RJ-45).....	17
2.6.7 LINE-OUT .....	17
2.6.8 Power On/Off Switch .....	18
2.6.9 SATA Power Connector.....	18
2.6.10 SATA Signal Connector .....	19
2.6.11 COM 1/2/3/4/5/6.....	19
2.6.12 DIO Port.....	20
2.7 Hard Disk Drive Installation .....	21

2.8	RAM Installation.....	24
2.9	Mini_Card Installation .....	26
2.10	Wallmount Installation.....	28
<b>Chapter 3 - AMI BIOS Setup.....</b>		<b>29</b>
3.1	System Test and Initialization .....	30
3.2	AMI BIOS Setup.....	31
3.3	Setup Submenu: Main.....	32
3.4	Setup Submenu: Advanced .....	33
3.4.1	Advanced: CPU Configuration.....	35
3.4.2	Advanced: SATA Configuration.....	37
3.4.3	Advanced: USB Configuration .....	38
3.4.4	Advanced: Hardware Monitor.....	40
3.4.5	Advanced: SIO Configuration .....	41
3.4.5.1	SIO Configuration: Serial Port 1/2/3/4/5/6 Configuration..	42
3.4.6	Advanced: Power Management.....	44
3.4.7	Advanced: Digital IO Port Configuration.....	46
3.5	Setup submenu: Chipset.....	47
3.5.1	Chipset: North Bridge Configuration .....	48
3.5.2	Chipset: South Bridge Configuration.....	50
3.6	Setup submenu: Security .....	51
3.7	Setup submenu: Boot.....	52
3.7.1	Boot: BBS Priorities .....	53
3.8	Setup submenu: Save & Exit.....	54
<b>Chapter 4 – Drivers Installation .....</b>		<b>55</b>
4.1	Product CD/DVD.....	56
<b>Appendix A - Watchdog Timer Programming.....</b>		<b>60</b>
A.1	Watchdog Timer Initial Program.....	61
A.2	Watchdog Sample Program .....	62

<b>Appendix C - I/O Information.....</b>	<b>65</b>
B.1 I/O Address Map.....	66
B.2 Memory Address Map.....	68
B.3 IRQ Mapping Chart.....	69
<b>Appendix C - Digital I/O Information .....</b>	<b>79</b>
C.1 Electrical Specifications for Digital I/O Ports .....	80
C.2 DIO Programming .....	81
C.3 DIO Register.....	82
C.4 DIO Sample Program.....	84

# Chapter 1

---

Product Specifications

## 1.1 Specifications

---

### System

- **Processor** Intel® Pentium® N3710 1.6GHz
- **Chipset** Intel® System on Chip
- **System Memory** 204-pin 1600 DDR3L SODIMM x 1, up to 8GB
- **Display Interface** VGA x 1  
HDMI x 1
- **Storage Device** mSATA, 2.5" HDD/SSD
- **Ethernet** Realtek RTL-8111E, 10/100/1000Base x2
- **I/O** RS-232/422/485 x 2  
RS-232 x 4  
USB3.0 x 2  
USB2.0 x 2  
VGA x 1  
HDMI x 1  
DIO x 1  
Line-Out x 1  
Antenna holes x 2  
Power switch  
Power input
- **Expansion Slot** Full-size Mini-Card x 1  
Half-size Mini-Card x 1 (optional for mSATA)
- **Indicator** Power LED x 1  
HDD Active LED x 1
- **OS Support** Windows® 10

Windows® 8.1 (32/64-bit)

WES7/WES8

Win10 IOT

Linux

## Mechanical

- **Mounting** Wallmount  
DIN Rail (optional)
- **Dimension (W x H x D)** 197 mm x 55 mm x 110 mm (7.8" x 2.2" x 4.3")
- **Gross Weight** 2.8 kg (6.6 lb)
- **Net Weight** 2 kg (4.4 lb)

## Environmental

- **Operating Temperature** -20°C ~ 60°C with W.T. SSD/HDD/mSATA  
(according to IEC68-2-14 with 0.5 m/s AirFlow ;  
with industrial devices)
- **Storage Temperature** -20°C ~ 70°C (-4°F ~ 158°F)
- **Storage Humidity** 95% @ 40°C, non-condensing
- **Anti-Vibration** 5 Grms/ 5~500Hz/ operation – mSATA/SSD  
1 Grms/ 5~500Hz/ operation – HDD
- **EMC** CE/FCC Class A

## Power Supply

- **DC Input** 9 - 30V with 3-pin terminal block (A2M)  
12V with lockable DC jack (A2)



# Chapter 2

---

Hardware Information

## 2.1 Dimensions

### A2

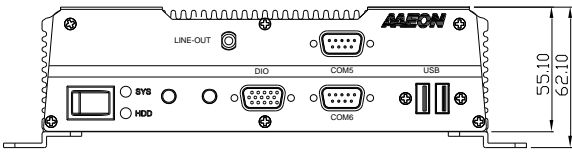
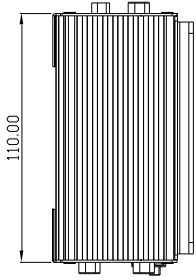
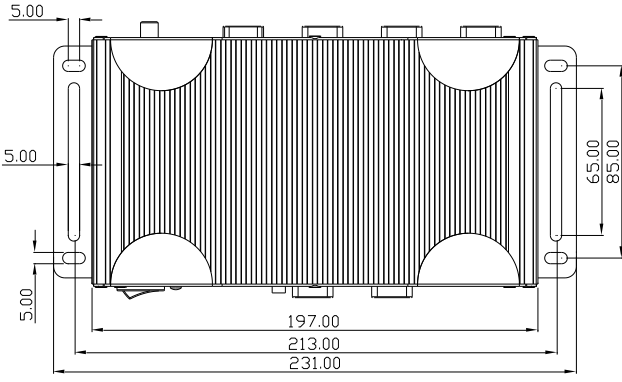
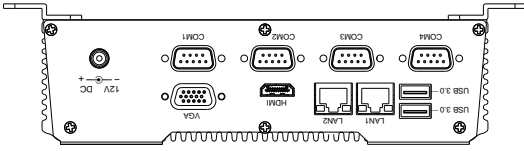

BOXER-6615-A2



## 2.2 Jumpers and Connectors

### Component Side

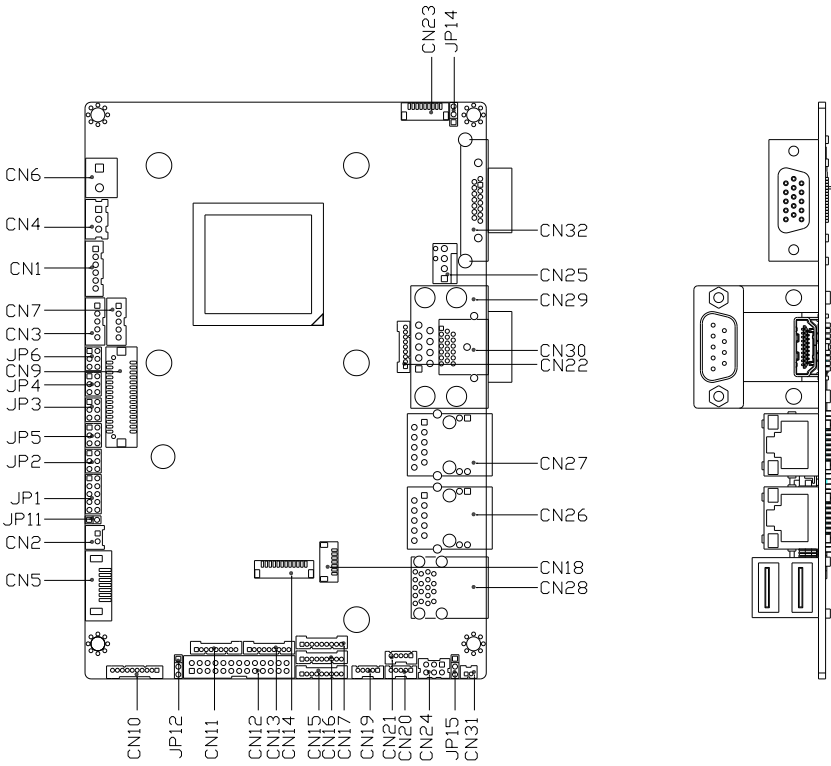

### Solder Side

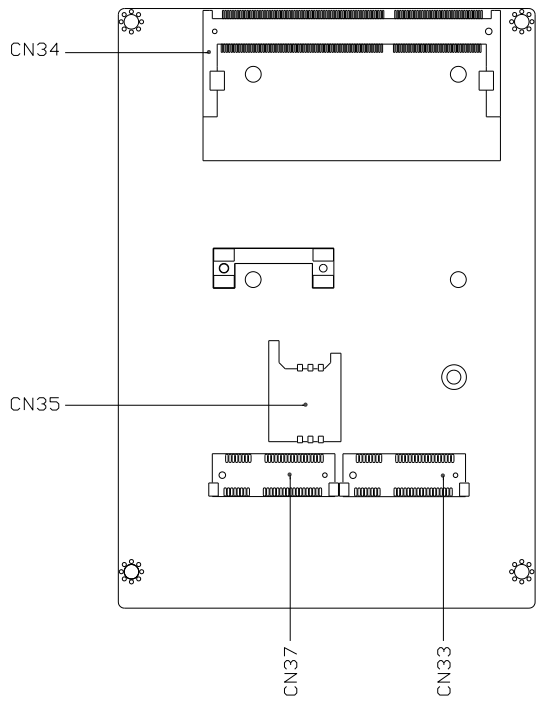

## 2.3 I/O Location

### Front

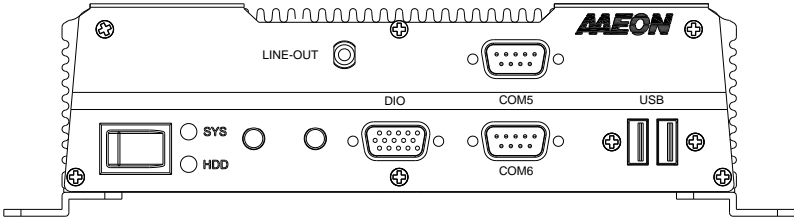

### Rear

#### A2

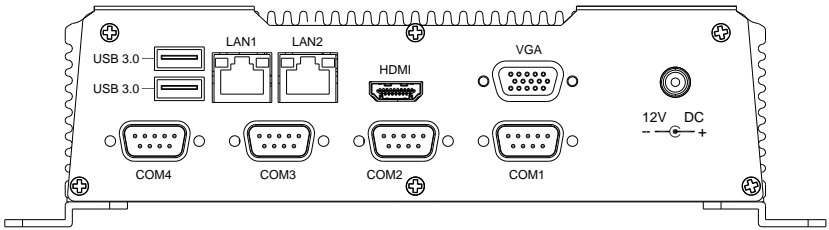

#### A2M

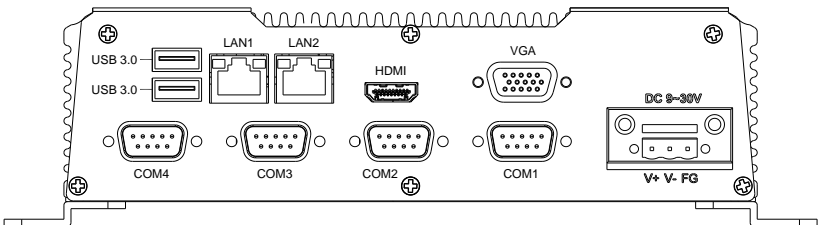

## 2.4 Block Diagram

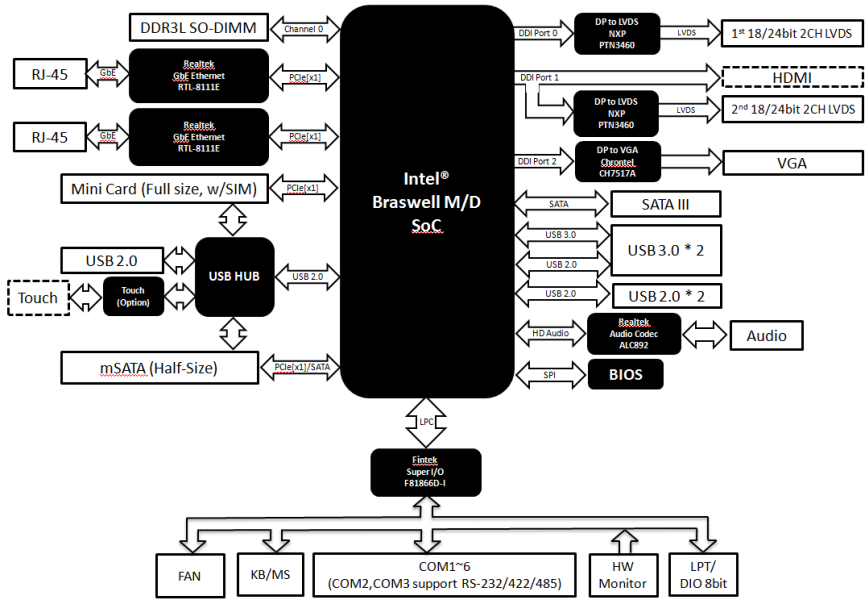

## 2.5 List of Jumpers

Please refer to the table below for all of the system's jumpers that you can configure for your application

Label	Function
JP2	COM3 Pin8 Function Selection
JP5	COM2 Pin8 Function Selection
JP12	Auto Power Button Enable/Disable Selection
JP15	Clear CMOS Jumper

### 2.5.1 COM3 Function Selection (JP2)

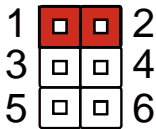

+12V

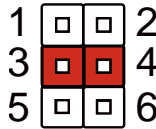

Ring (default)

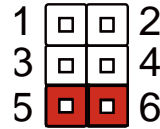

+5V

### 2.5.2 COM2 Function Selection (JP5)

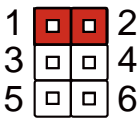

+12V

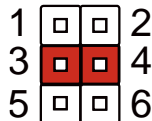

Ring (default)

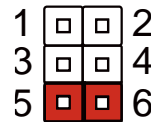

+5V



### 2.5.3 Auto Power Button Enable/Disable Selection (JP12)

---

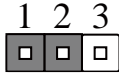

ATX Mode (default)

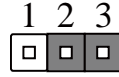

AT Mode

### 2.5.4 Clear CMOS Jumper (JP15)

---

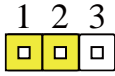

Normal (default)

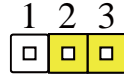

Clear CMOS

## 2.6 List of Connectors

---

Please refer to the table below for all of the system's connectors that you can configure for your application

Label	Function
VGA	DB-15 CRT port
DC-IN	DC-IN connector
HDMI	HDMI connector
DIO	8- bit Digital Input & Output connector
USB 3.0 Port	USB 3.0 Port
USB Port	USB 2.0 Port
LAN Port	RJ45 10/100/1000Mbps LAN connector
LINE-OUT	3.5mm Audio Line-out connector
Power Switch	Power on/off switch
COM 1/2/3/4/5/6	DB9 RS232/422/485 connector
SATA Power Connector	SATA Storage power connector
SATA Signal Connector	SATA Storage signal connector

## 2.6.1 VGA Port

---

Pin	Signal	Pin	Signal
1	Red	2	Green
3	Blue	4	NC
5	GND	6	GND
7	GND	8	GND
9	VGA_VCC	10	GND
11	NC	12	DDC_DATA
13	VGA_HSYNC	14	VGA_VSYNC
15	DDC_CLK		

## 2.6.2 DC-IN

---

Pin	Signal	Pin	Signal
1	PWR_IN	2	GND
3	NC		

## 2.6.3 HDMI Port

---

Pin	Signal	Pin	Signal
1	HDMI_DATA2_P	2	GND
3	HDMI_DATA2_N	4	HDMI_DATA1_P
5	GND	6	HDMI_DATA1_N
7	HDMI_DATA0_P	8	GND
9	HDMI_DATA0_N	10	HDMI_CLK_P

Pin	Signal	Pin	Signal
11	GND	12	HDMI_CLK_N
13	NC	14	NC
15	HDMI_SCL	16	HDMI_SDA
17	GND	18	HDMI_PWR
19	HDMI_HDP		

## 2.6.4 USB 3.0 Port

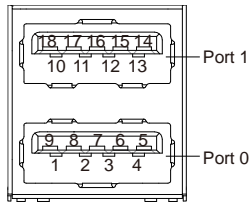

Pin	Pin Name	Signal Type	Signal Level
1	+5VSB	PWR	+5V
2	USB0_D-	DIFF	
3	USB0_D+	DIFF	
4	GND	GND	
5	USB0_SSRX-	DIFF	
6	USB0_SSRX+	DIFF	
7	GND	GND	
8	USB0_SSTX-	DIFF	
9	USB0_SSTX+	DIFF	
10	+5VSB	PWR	+5V
11	USB1_D-	DIFF	
12	USB1_D+	DIFF	

Pin	Pin Name	Signal Type	Signal Level
13	GND	GND	
14	USB1_SSRX-		
15	USB1_SSRX+		
16	GND	GND	
17	USB1_SSTX-		
18	USB1_SSTX+		

## 2.6.5 USB 2.0 Port

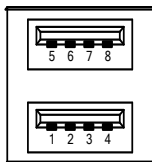

### Port 0

Pin	Signal	Pin	Signal
1	USB VCC (+5V level)	2	USB #0_D-
3	USB #0_D+	4	Ground (GND)

### Port 1

Pin	Signal	Pin	Signal
5	USB VCC (+5V level)	6	USB #1_D-
7	USB #1_D+	8	Ground (GND)

## 2.6.6 LAN (RJ-45)

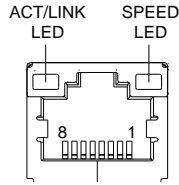

Pin	Pin Name	Signal	Signal Level
1	MDI0+	DIFF	
2	MDI0-	DIFF	
3	MDI1+	DIFF	
4	MDI2+	DIFF	
5	MDI2-	DIFF	
6	MDI1-	DIFF	
7	MDI3+	DIFF	
8	MDI3-	DIFF	

## 2.6.7 LINE-OUT

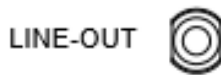

Pin	Pin Name	Signal	Signal Level
1	Line	Line	

## 2.6.8 Power On/Off Switch

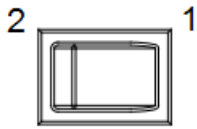

Pin	Signal	Pin	Signal
1	GND	2	PSIN

## 2.6.9 SATA Power Connector

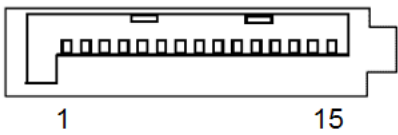

Pin	Signal	Pin	Signal
1	+3.3VDC	2	+3.3VDC
3	+3.3VDC	4	COM
5	COM	6	COM
7	+5VDC	8	+5VDC
9	+5VDC	10	COM
11	COM	12	COM
13	+12VDC	14	+12VDC
15	+12VDC		

## 2.6.10 SATA Signal Connector

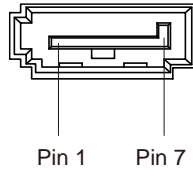

Pin	Pin name	Signal Type	Signal Level
1	GND	GND	-
2	SATA_TX+	DIFF	-
3	SATA_TX-	DIFF	-
4	GND	GND	-
5	SATA_RX-	DIFF	-
6	SATA_RX+	DIFF	-
7	GND	GND	-

## 2.6.11 COM 1/2/3/4/5/6

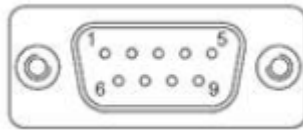

Pin	RS-232	RS-422	RS-485
1	DCD	TX-	DATA-
2	RXD	TX+	DATA+
3	TXD	RX+	NC
4	DTR	RX-	NC
5	GND	NC	NC
6	DSR	NC	NC



Pin	RS-232	RS-422	RS-485
7	RTS	NC	NC
8	CTS	NC	NC
9	RI	NC	NC

### 2.6.12 DIO Port

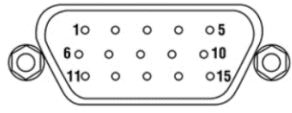

Pin	Signal	Pin	Signal
1	DIO 0	2	DIO 1
3	DIO 2	4	DIO 3
5	DIO 4	6	DIO 5
7	DIO 6	8	DIO 7
9	GND	10	+5V

## 2.7 Hard Disk Drive Installation

Step 1: Remove the baseplate as instructed below

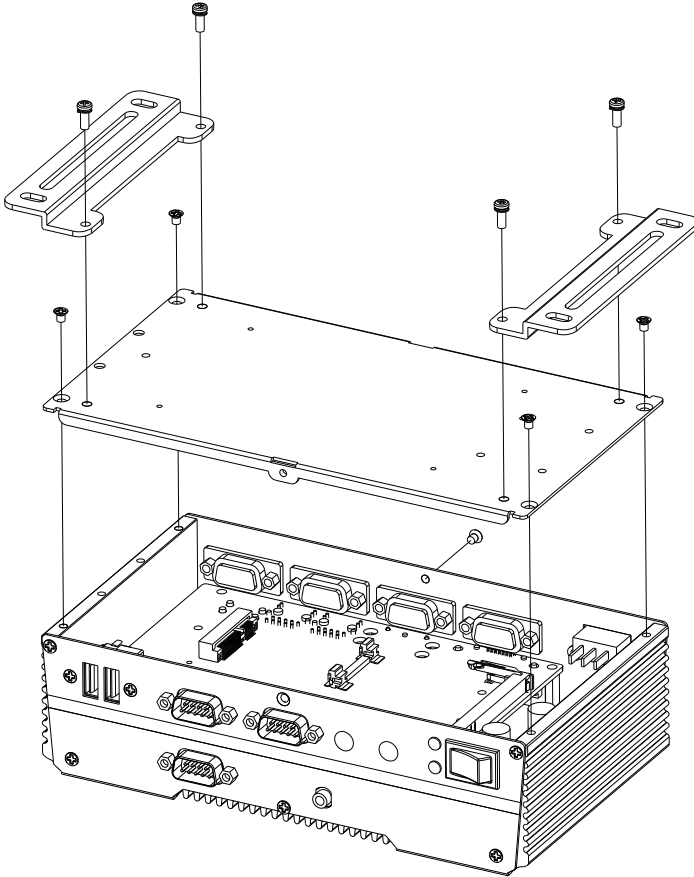

Step 2: Place the HDD on the bracket plate



Step 3: Tighten the screws at the back to secure the HDD

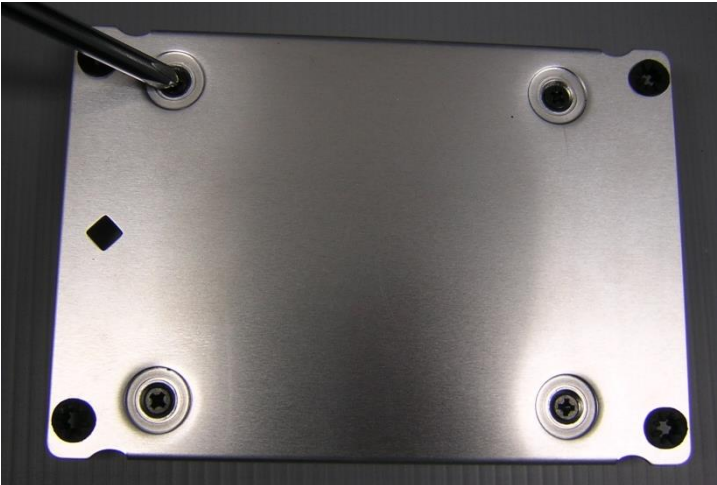

Step 4: Connect the SATA and power cables to the HDD, attach the HDD assembly to the baseplate.

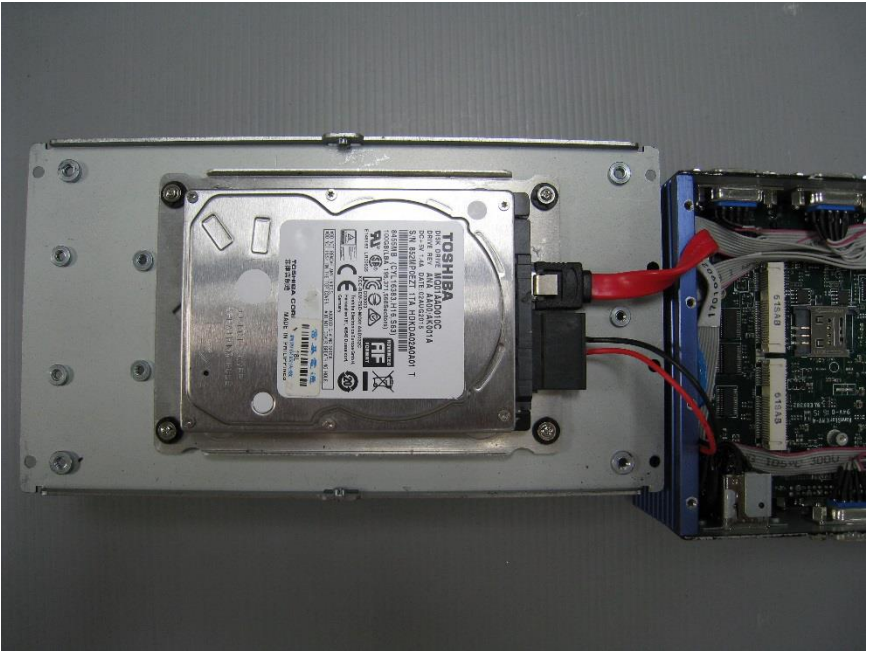

## 2.8 RAM Installation

Step 1: Remove the baseplate as instructed below

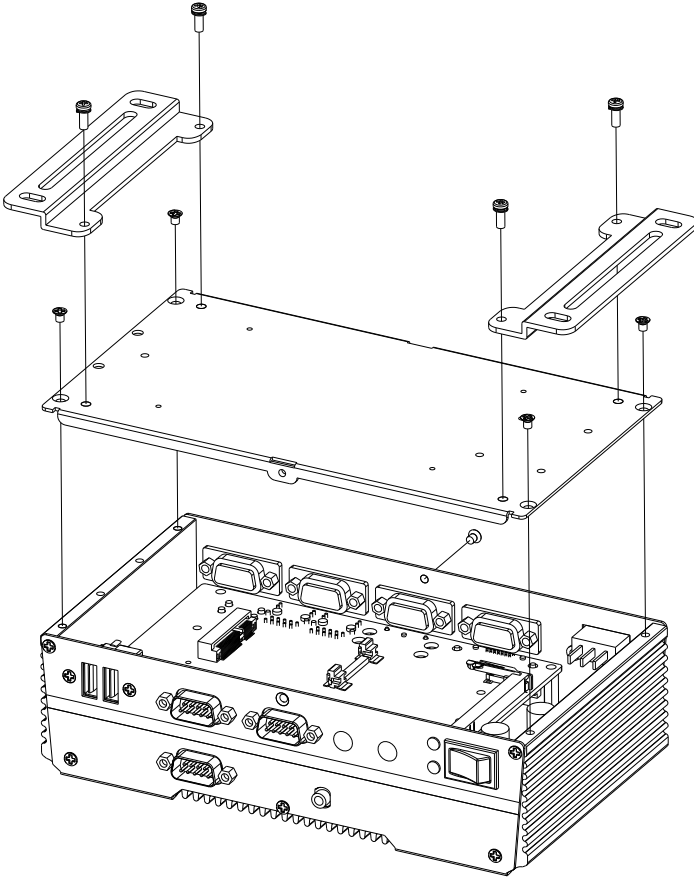

Step 2: Insert the RAM into the RAM slot

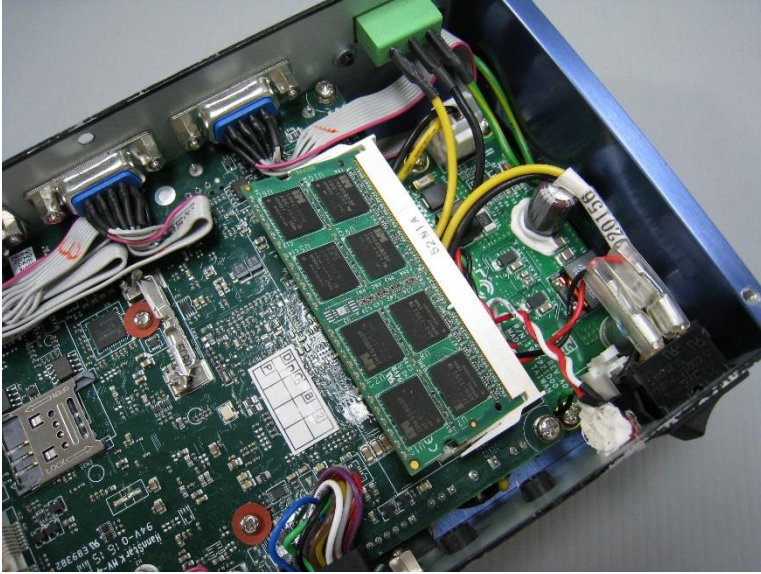

Step 3: Push down to secure the RAM

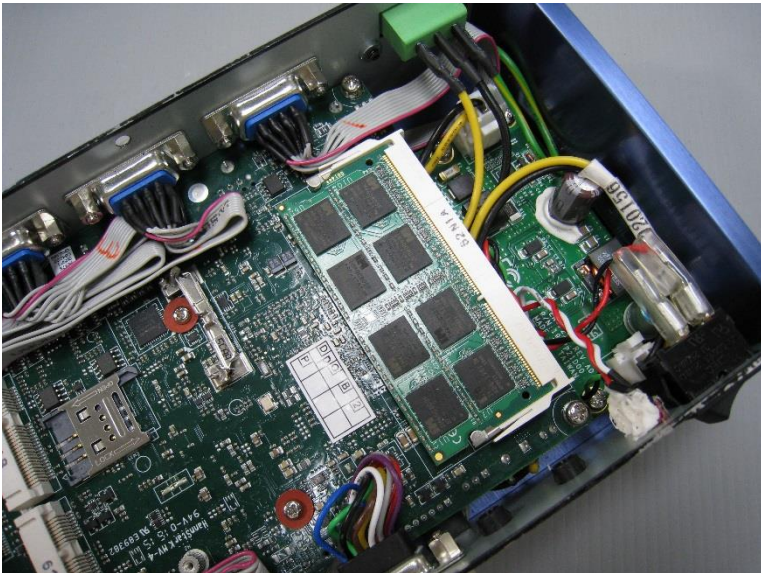

## 2.9 Mini\_Card Installation

Step 1: Remove the baseplate as instructed below

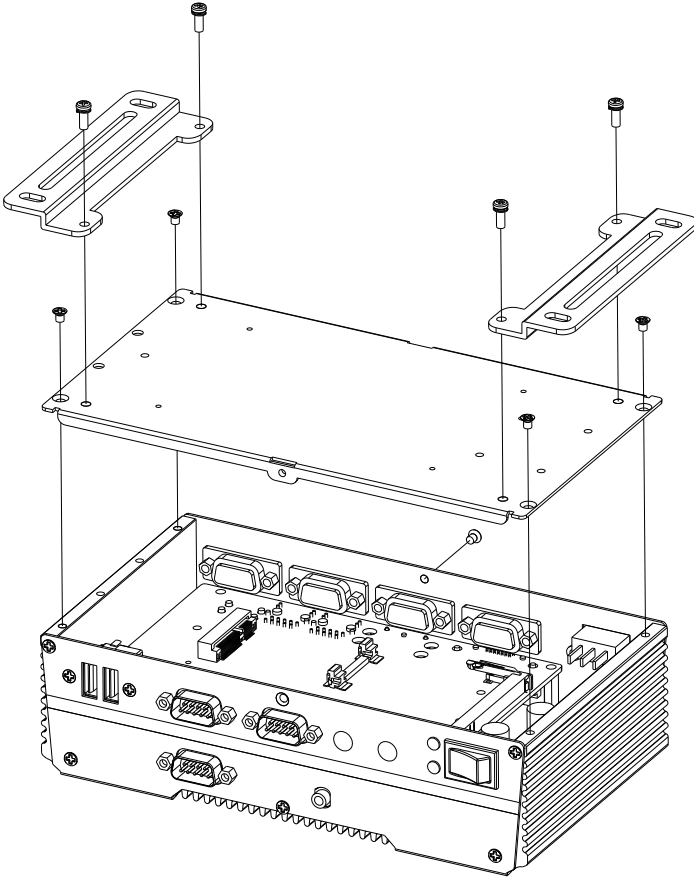



Step 2: Insert the Mini-Card into the Mini-Card slot



Step 3: Push down to secure the Mini-Card





## 2.10 Wallmount Installation

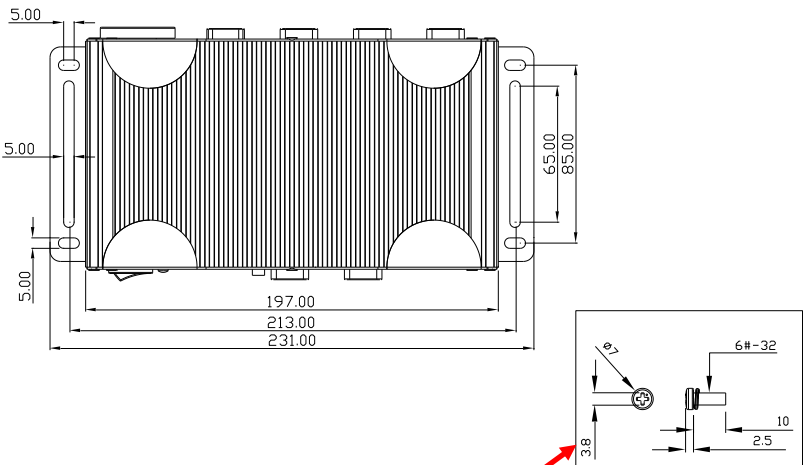
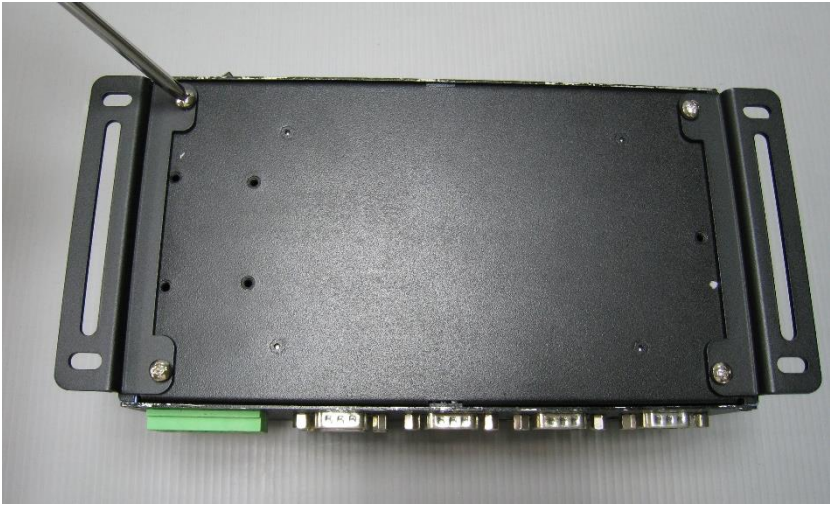

We suggest using this screw.

# Chapter 3

---

AMI BIOS Setup

## 3.1 System Test and Initialization

---

The system uses certain routines to perform testing and initialization. If an error, fatal or non-fatal, is encountered, a few short beeps or an error message will be outputted. The board can usually continue the boot up sequence with non-fatal errors.

The system configuration verification routines check the current system configuration against the values stored in the CMOS memory. If they do not match, an error message will be outputted, in which case you will need to run the BIOS setup program to set the configuration information in memory.

There are three situations in which you will need to change the CMOS settings:

- You are starting your system for the first time
- You have changed your system's hardware
- The CMOS memory has lost power and the configuration information is erased

The system's CMOS memory uses a backup battery for data retention, which is to be replaced once emptied.

## 3.2 AMI BIOS Setup

---

The AMI BIOS ROM has a pre-installed Setup program that allows users to modify basic system configurations, which is stored in the battery-backed CMOS RAM and BIOS NVRAM so that the information is retained when the power is turned off.

To enter BIOS Setup, press <Del> or <F2> immediately while your computer is powering up.

The function for each interface can be found below.

**Main** – Date and time can be set here. Press <Tab> to switch between date elements

**Advanced** – Enable/ Disable boot option for legacy network devices

**Chipset** – For hosting bridge parameters

**Security** – The setup administrator password can be set here

**Boot** – Enable/ Disable quiet Boot Option

**Save & Exit** – Save your changes and exit the program

### 3.3 Setup Submenu: Main

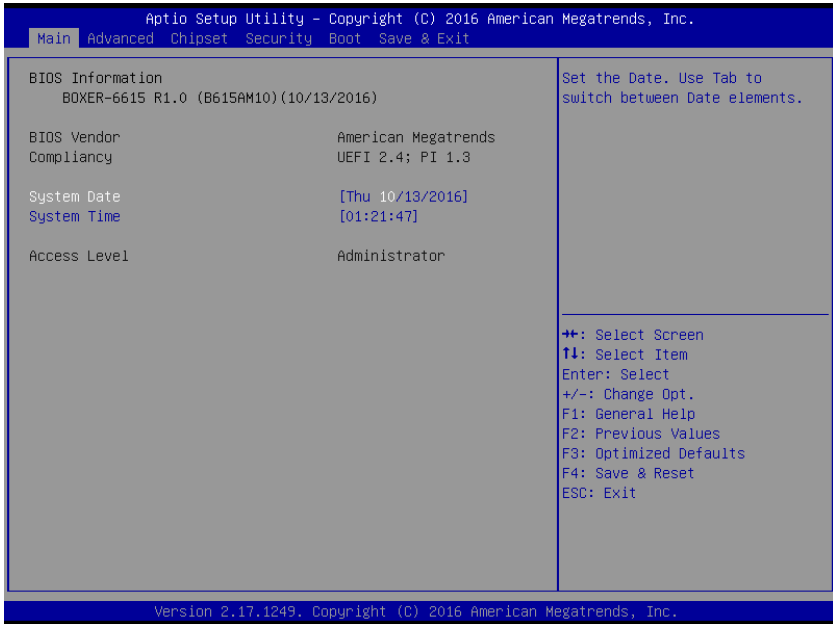

Options summary: (*default setting*)

System Date	Day MM:DD:YYYY	
Change the month, year and century. The 'Day' is changed automatically.		
System Time	HH : MM : SS	
Change the clock of the system.		

### 3.4 Setup Submenu: Advanced

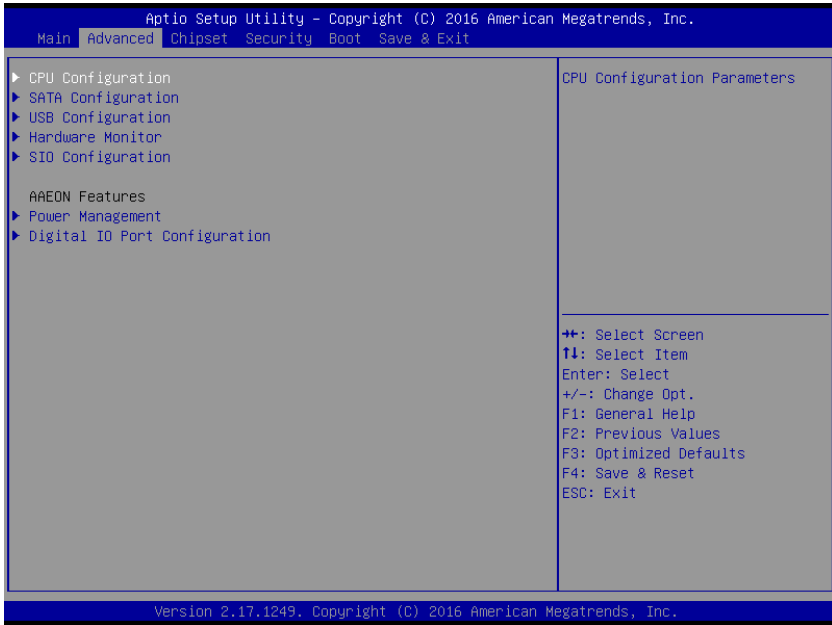

Options summary: (*default setting*)

CPU Configuration		
CPU Configuration Parameters		
SATA Configuration		
SATA Device Options Settings		
USB Configuration		
USB Configuration Parameters		
Hardware Monitor		
Monitor hardware status		
SIO Configuration		
Super IO Configuration Parameters		

Power Management		
System ACPI/Power Mode/Wake Event Configuration		
Digital IO Port Configuration		
DIO configuration		

### 3.4.1 Advanced: CPU Configuration

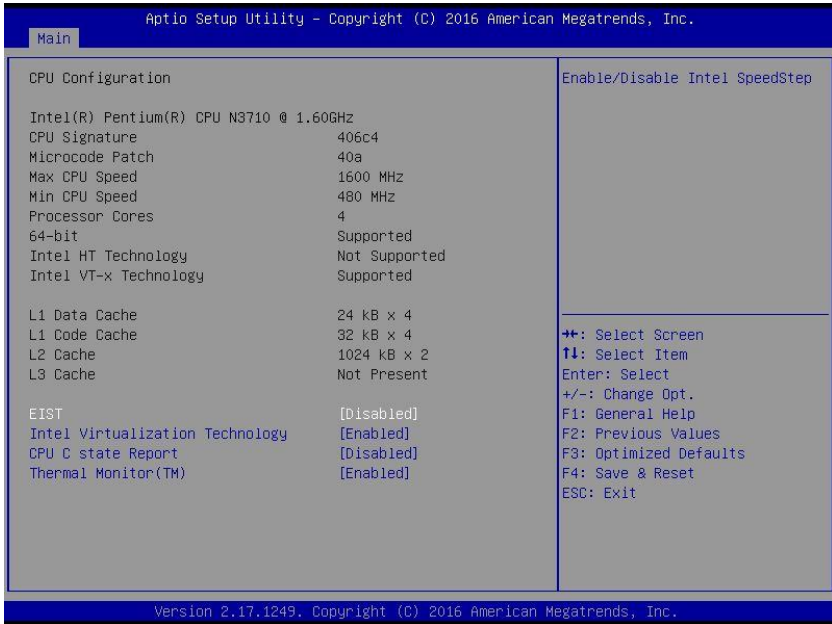

Options summary: (*default setting*)

EIST	<i>Enabled</i>	
	Disabled	
Enable/Disable Intel SpeedStep feature.		
	<i>Enabled</i>	
	Disabled	
En/Disable Turbo mode.		
	<i>Enabled</i>	
	Disabled	
When enabled, a VMM can utilize the additional hardware capabilities provide by Vanderpool Technology		



Thermal Monitor (TM)	<i>Enabled</i>	
	Disabled	
Enable/Disable CPU Thermal Monitor		

### 3.4.2 Advanced: SATA Configuration

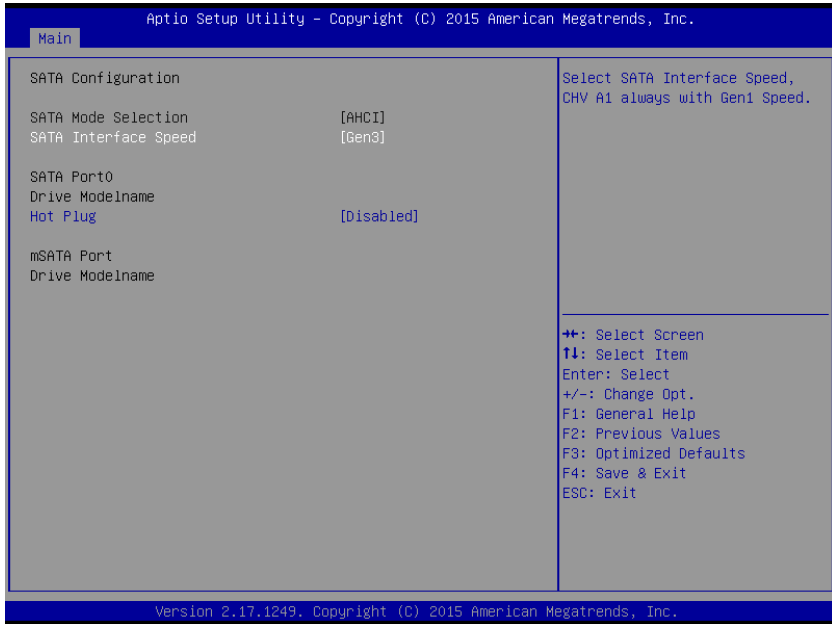

Options summary: (*default setting*)

SATA Speed Support	<b>Gen3</b>	
	Gen2	
	Gen1	
SATA Speed Support Gen3, Gen2 or Gen1		
SATA Mode	<b>AHCI Mode</b>	
Only AHCI mode support on this platform		
	<b>Enabled</b>	
	Disabled	
Enabled/Disabled SATA Port0/Port1 HotPlug function		

### 3.4.3 Advanced: USB Configuration

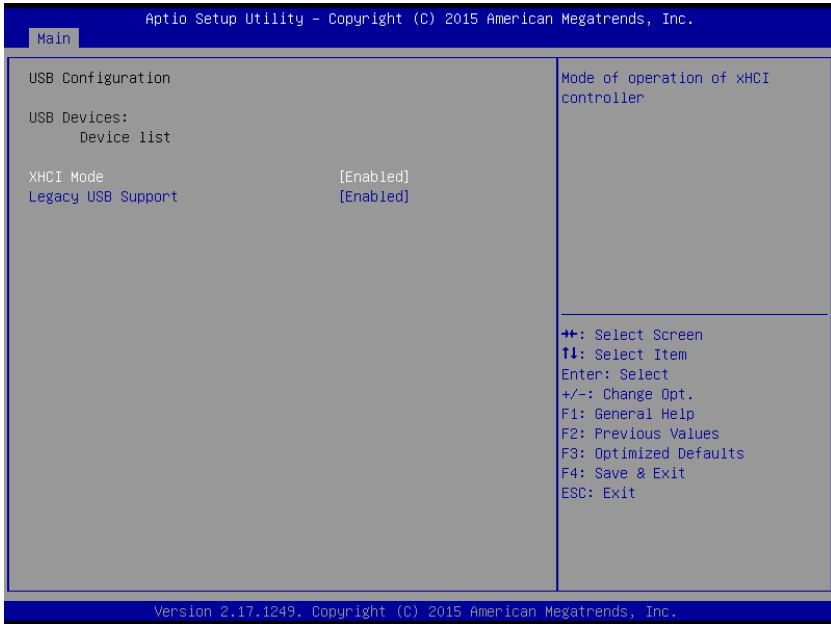

Options summary: (*default setting*)

XHCI Mode	<i>Enabled</i>	
	Disabled	
Enable/Disable for xHCI controller:		
	Enabled	
	<i>Disabled</i>	
Control the USB EHCI (USB 2.0) functions. This item active when xHCI controller disabled because all ports are routed to xHCI controller when xHCI enabled.		
	<i>Enabled</i>	
	Disabled	
	Auto	

Enables BIOS Support for Legacy USB Support. When enabled, USB can be functional in legacy environment like DOS. AUTO option disables legacy support if no USB devices are connected. DISABLE option will keep USB devices available only for EFI application

### 3.4.4 Advanced: Hardware Monitor

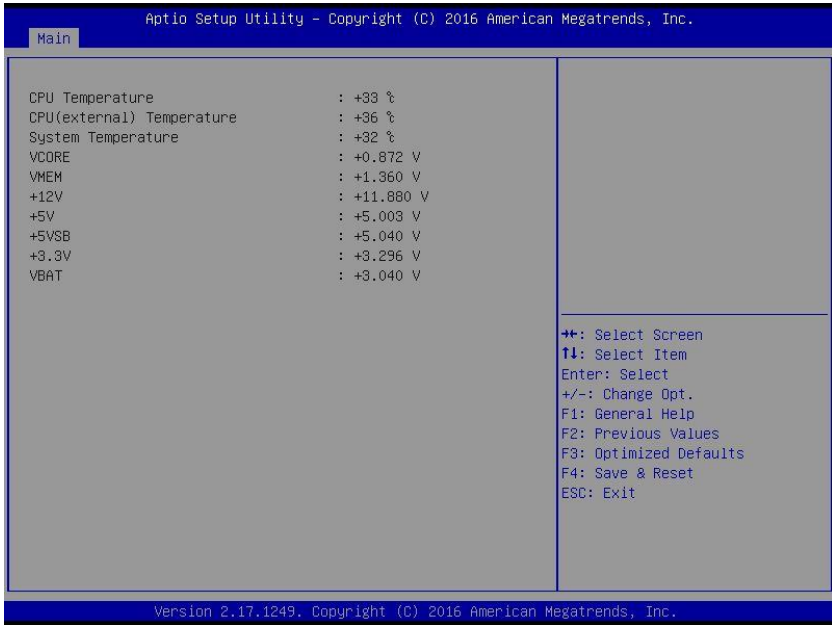

Options summary: (*default setting*)

Smart Fan	Disabled	
	<i>Enabled</i>	
En/Disable specified Smart Fan.		

### 3.4.5 Advanced: SIO Configuration

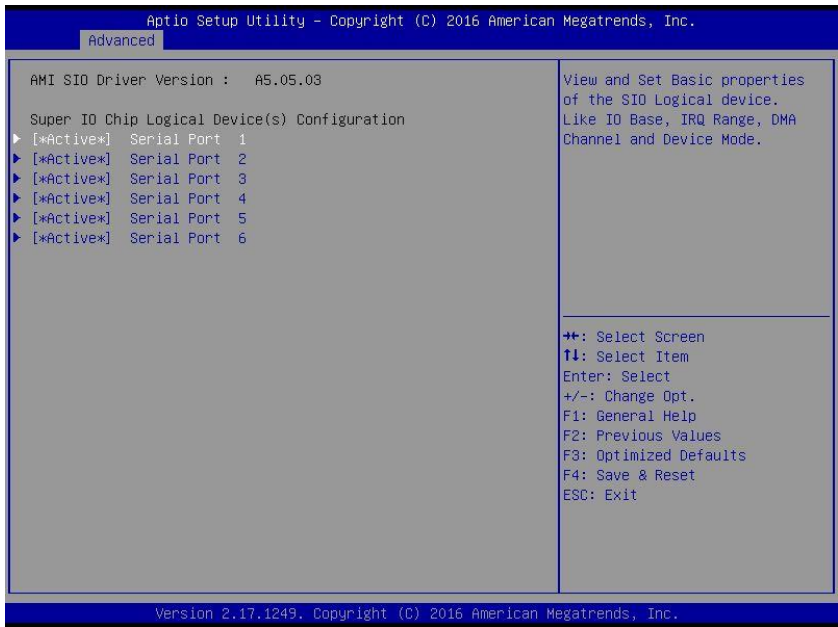

Options summary: (*default setting*)

Parallel Port/Serial Port		
1/2/3/4/5/6 Configuration		
Set Parameters of Serial Port 1/2/3/4/5/6		

### 3.4.5.1 SIO Configuration: Serial Port 1/2/3/4/5/6 Configuration

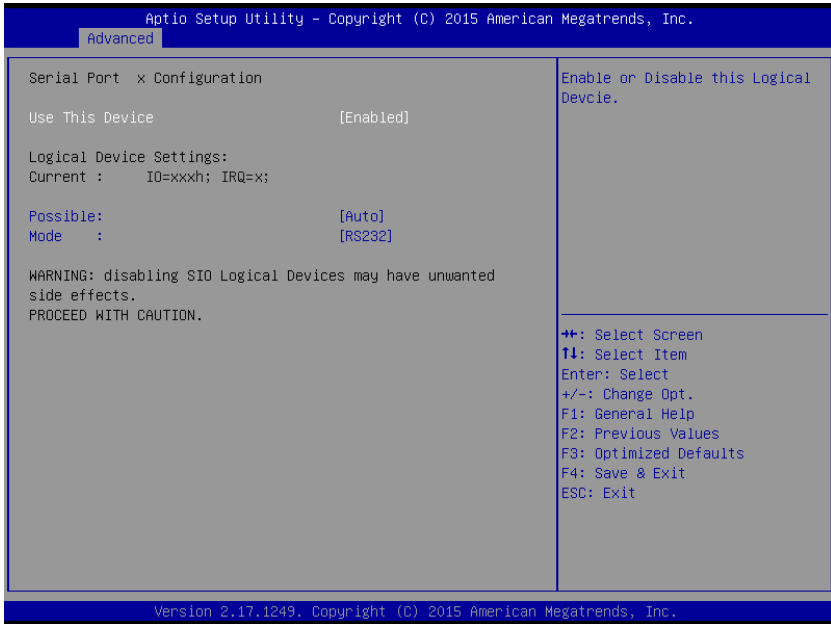

Options summary: (*default setting*)

Use This Device	Disabled	
	<i>Enabled</i>	
En/Disable specified serial port.		
	<i>Use Automatic Settings</i>	
	IO=3F8h; IRQ=4;	
	IO=2F8h; IRQ=3;	
	<i>Use Automatic Settings</i>	
	IO=2F8h; IRQ=3;	
	IO=3F8h; IRQ=4;	
	<i>Use Automatic Settings</i>	
	IO=3E8h; IRQ=11;	

	IO=2E8h; IRQ=11;	
	<i>Use Automatic Settings</i>	
	IO=2E8h; IRQ=11;	
	IO=3E8h; IRQ=11;	
Select a resource setting for Super IO device.		
	<i>Use Automatic Settings</i>	
	IO=2D0h; IRQ=11;	
	IO=2C0h; IRQ=11;	
Select a resource setting for Super IO device.		
	<i>Use Automatic Settings</i>	
	IO=2C0h; IRQ=11;	
	IO=2D0h; IRQ=11;	
Select a resource setting for Super IO device.		
	<i>RS232</i>	
	RS422	
	RS485	
Configure COM operated as RS232, RS422 or RS485. Only COM2 and COM3 support this function.		



### 3.4.6 Advanced: Power Management

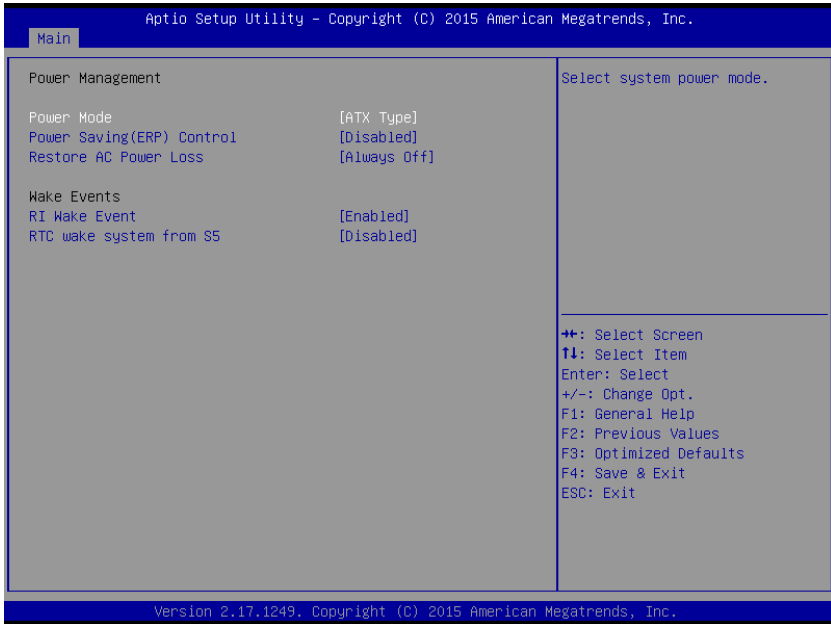

Options summary: (*default setting*)

Power Mode	<i>ATX Type</i>	
	AT Type	
Select system power mode		
	Enabled	
	<i>Disabled</i>	
Enabled or disabled ERP feature for power saving in S5 state.		
	<i>Power Off</i>	
	Power on	
	Late State	
Select AC power state when power is re-applied after a power failure		
	<i>Enabled</i>	

	Disabled	
Enabled or disabled wake on ring function.		
	<i>Disabled</i>	
	Fixed Time	
	Dynamic Time	
Enable system to wake from S5 using RTC alarm.		
Wake up day	0-31	
Select 0 for daily system wake up 1-31 for which day of the month that you would like the system to wake up		
Wake up hour	0-23	
Wake up minute	0-59	
Wake up second	0-59	
Wake up minute increase	1-5	

### 3.4.7 Advanced: Digital IO Port Configuration

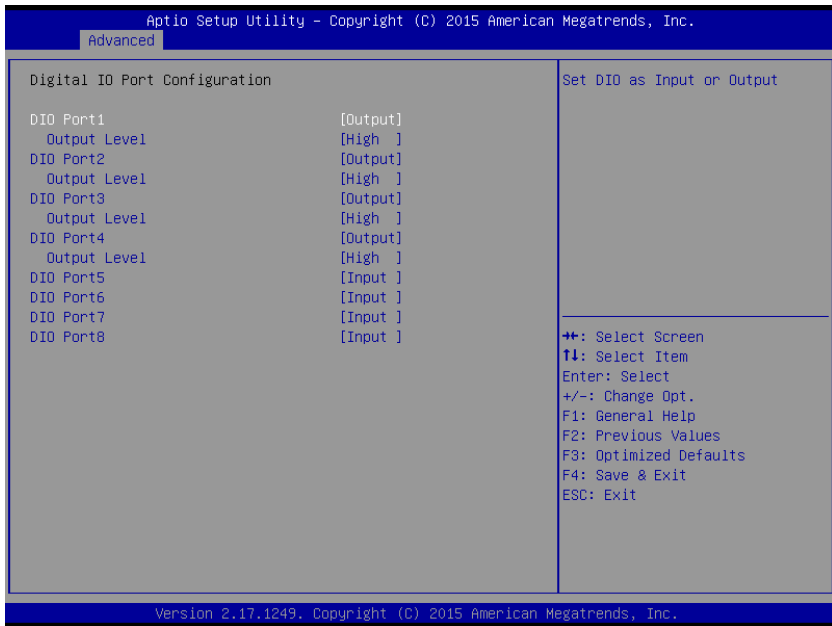

Options summary: (*default setting*)

DIO Port1/2/3/4	Input	
	<i>Output</i>	
Set DIO Port1/2/3/4 as Input or Output		
	<i>Input</i>	
	Output	
Set DIO Port5/6/7/8 as Input or Output		
	High	
	<i>Low</i>	
Set DIO Level when used as Output		

### 3.5 Setup submenu: Chipset

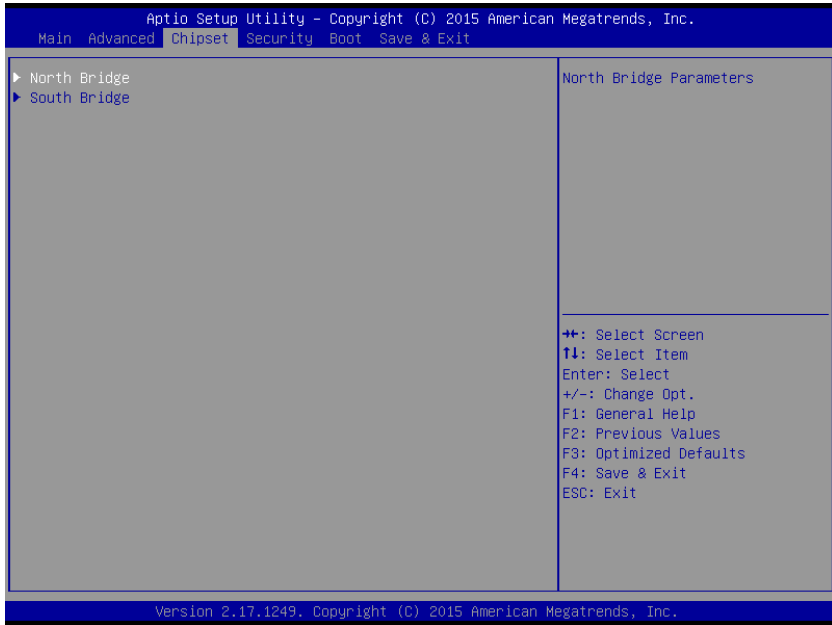

Options summary: (*default setting*)

North Bridge Configuration		
North Bridge Parameters.		
South Bridge		
South Bridge Parameters		

### 3.5.1 Chipset: North Bridge Configuration

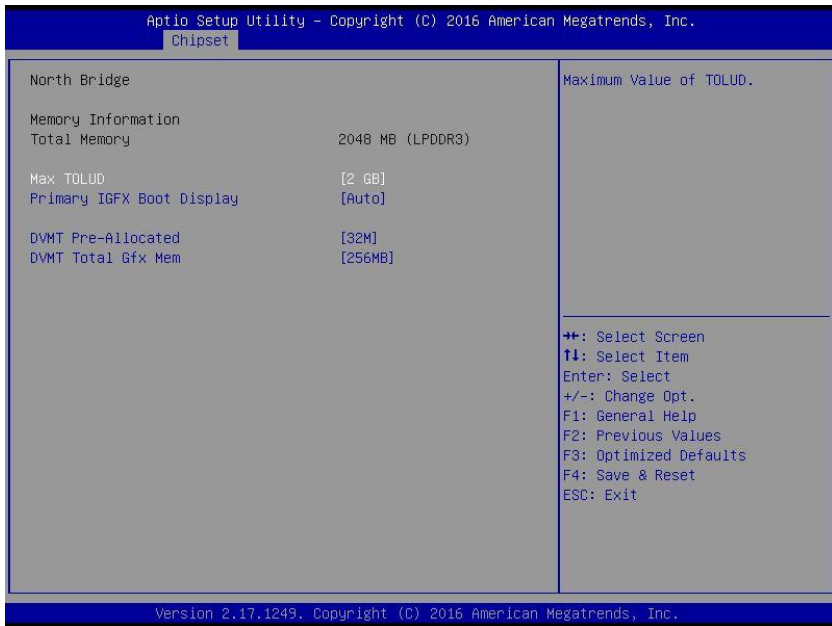

Options summary: (*default setting*)

Max TOLUD	<b>2 GB</b>	
	2.25 GB	
	2.5 GB	
	2.75 GB	
Maximum Value of TOLUD		
	<b>Auto</b>	
	CRT	
	LVDS1	
	LVDS2/HDMI	
Select Primary boot display device		
	<b>Disabled</b>	

	CRT	
	LVDS1	
	LVDS2/HDMI	
Select Primary boot display device		
	<b>32MB</b>	
	32MB~512MB	
Select DVMT 5.0 Pre-Allocated (Fixed) Graphics Memory size used by the Internal Graphics Device.		
	128MB	
	<b>256MB</b>	
	Max	
Select DVMT 5.0 Total Graphic Memory size used by the IGD.		

### 3.5.2 Chipset: South Bridge Configuration

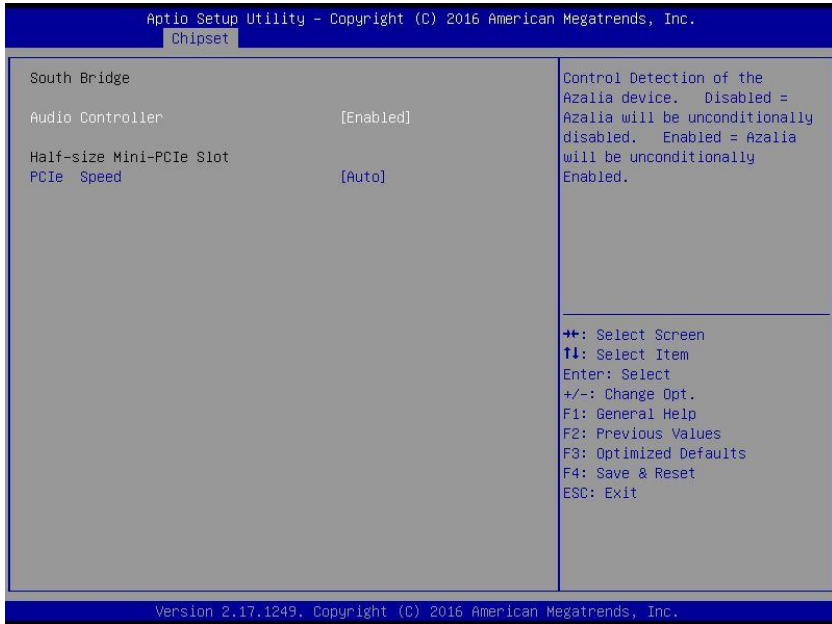

Options summary: (*default setting*)

Audio Controller	<i>Enabled</i>	
	Disabled	
Control Detection of the Azalia device. Disabled = Azalia will be unconditionally disabled. Enabled = Azalia will be unconditionally Enabled.		
	<i>Auto</i>	
	Gen 2	
	Gen 1	
Configuration PCIe Speed.		

## 3.6 Setup submenu: Security

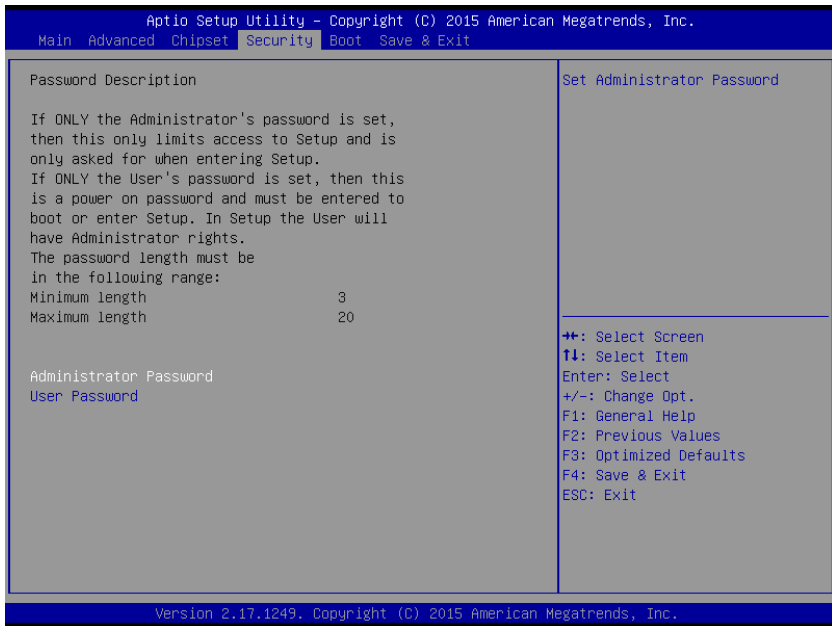

### Change User/Administrator Password

You can set a User Password once an Administrator Password is set. The password will be required during boot up, or when the user enters the Setup utility. Please Note that a User Password does not provide access to many of the features in the Setup utility. Select the password you wish to set, press Enter to open a dialog box to enter your password (you can enter no more than six letters or numbers). Press Enter to confirm your entry, after which you will be prompted to retype your password for a final confirmation. Press Enter again after you have retyped it correctly.

### Removing the Password

Highlight this item and type in the current password. At the next dialog box press Enter to disable password protection.



### 3.7 Setup submenu: Boot

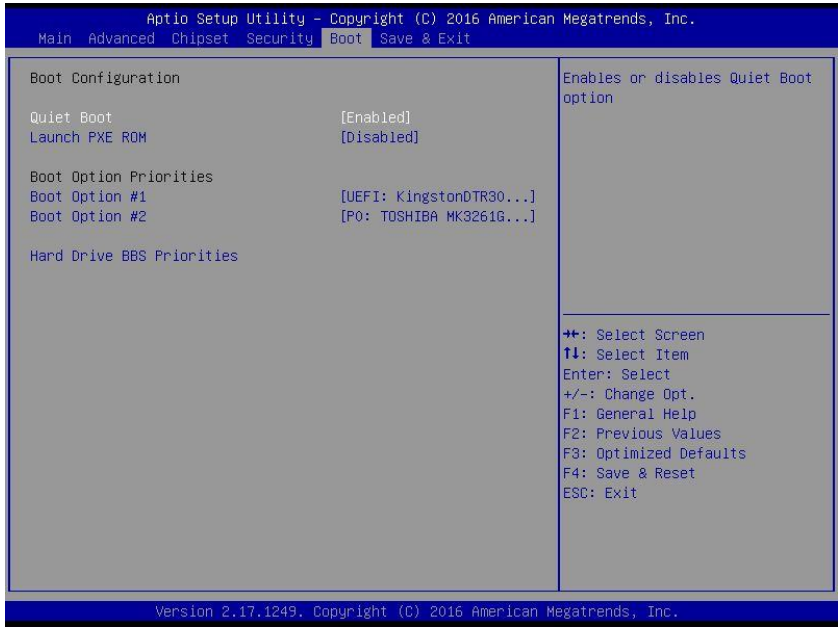

Options summary: (*default setting*)

Quiet Boot	Disabled	
	<i>Enabled</i>	
En/Disable showing boot logo.		
	<i>Disabled</i>	
	Enabled	
En/Disable network ROM for legacy PXE boot		
Boot Option #X/ XXXX Drive BBS Priorities		
The order of boot priorities.		

### 3.7.1 Boot: BBS Priorities

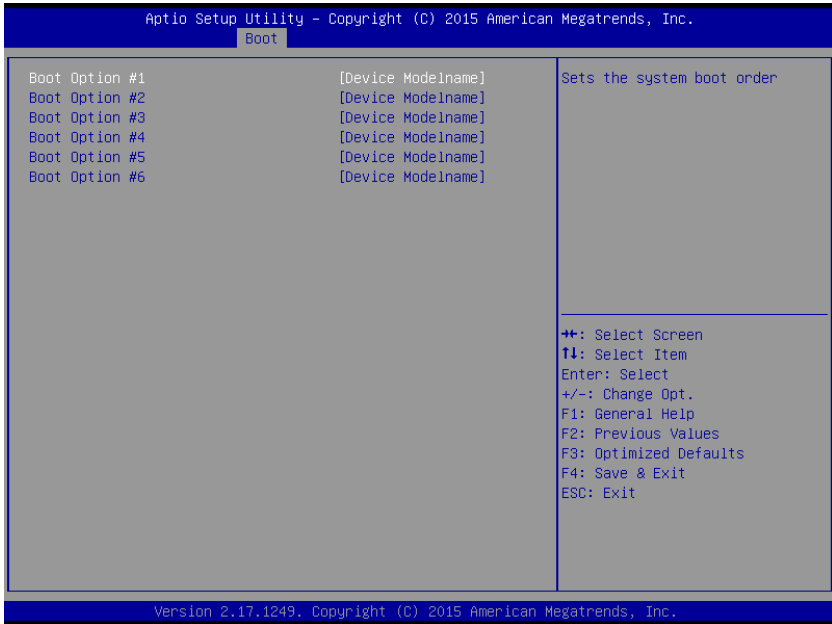

Options summary: (*default setting*)

Boot Option #x	Disabled	
	Device name	
Sets the system boot order		

### 3.8 Setup submenu: Save & Exit

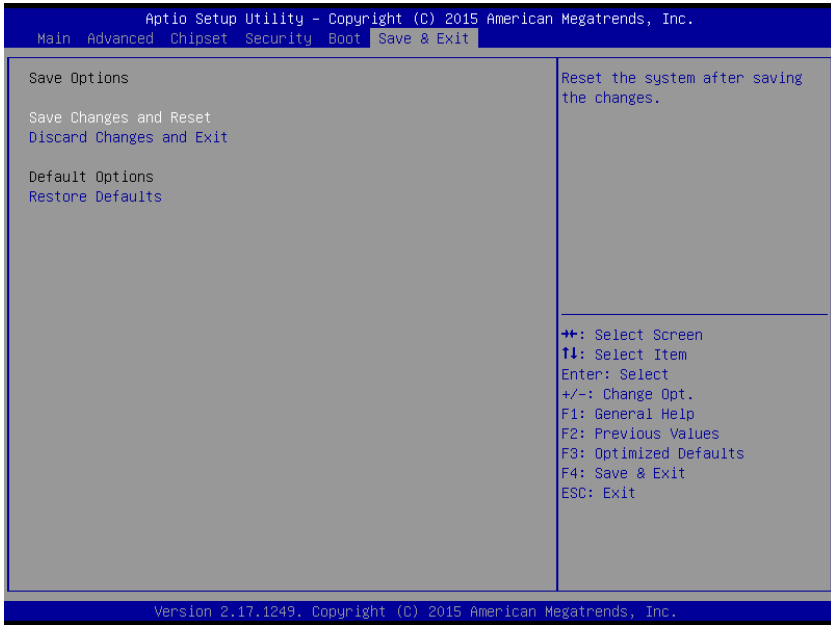

Options summary: (*default setting*)

Save Changes and Reset		
Reset the system after saving the changes		
Discard Changes and Exit		
Reset system setup without saving any changes		
Restore Defaults		
Restore/Load Default values for all the setup options.		

# Chapter 4

---

Drivers Installation

## 4.1 Product CD/DVD

---

The BOXER-6615 comes with a product DVD that contains all the drivers and utilities you need to setup your product. Insert the DVD and follow the steps in the autorun program to install the drivers.

In case the program does not start, follow the sequence below to install the drivers.

### Step 1 – Install Chipset Driver

1. Open the **Step1 - Chipset** folder and followed by **SetupChipset.exe** file
2. Follow the instructions
3. Drivers will be installed automatically

### Step 2 – Install VGA Driver

1. Open the **Step2 - Graphic** folder and select your OS
2. Open the **Setup.exe** file in the folder
3. Follow the instructions
4. Drivers will be installed automatically

### Step 3 – Install Audio Driver

1. Open the **Step3 - Audio** folder and select your OS
2. Open the **Setup.exe** file in the folder
3. Follow the instructions
4. Drivers will be installed automatically

### Step 4 – Install LAN Driver

1. Open the **Step4 - LAN** folder and select your OS
2. Open the **setup.exe** file in the folder

3. Follow the instructions
4. Drivers will be installed automatically

#### Step 5 – Install TXE Driver

1. Open the **Step6 - TXE** folder and followed by **Setup.exe** file
2. Follow the instructions
3. Drivers will be installed automatically

#### Step 6 – Install USB3.0 Driver

1. Open the **Step6 – USB3.0** folder and select your OS
2. Open the **.exe** file in the folder
3. Follow the instructions
4. Drivers will be installed automatically

## Step 7 – Install Serial Port Driver (Optional)

For Windows 7:

1. Change User Account Control settings to **Never notify**

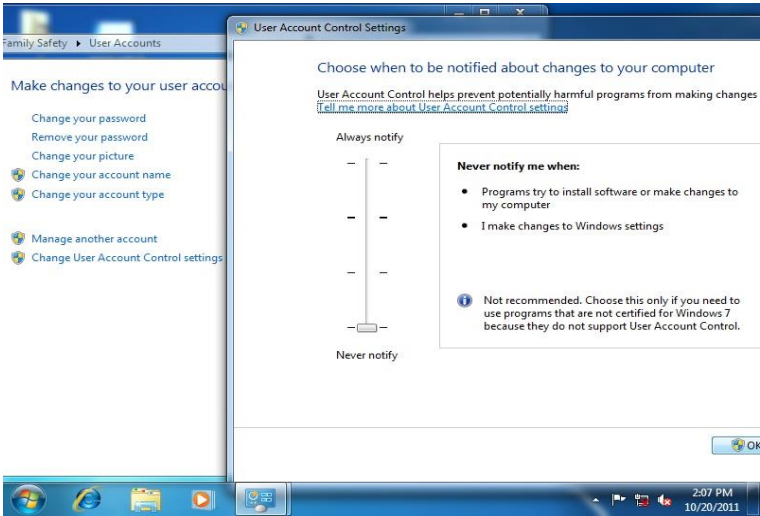

2. Reboot and log in as administrator

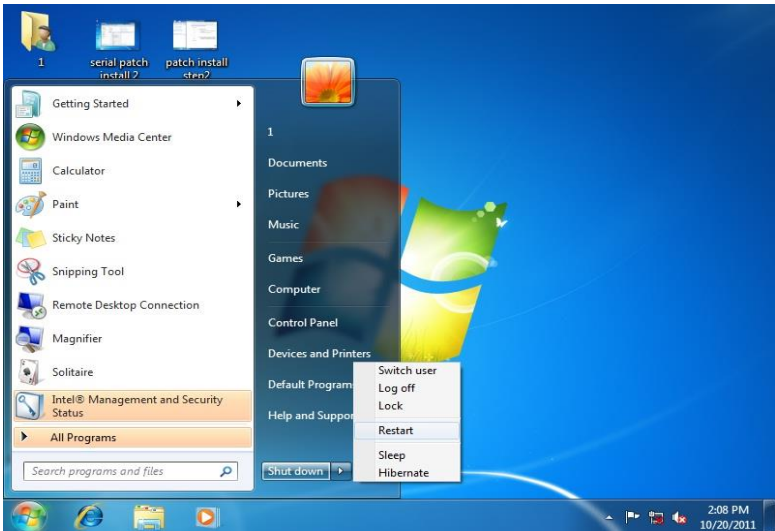

3. Run **patch.bat** as administrator

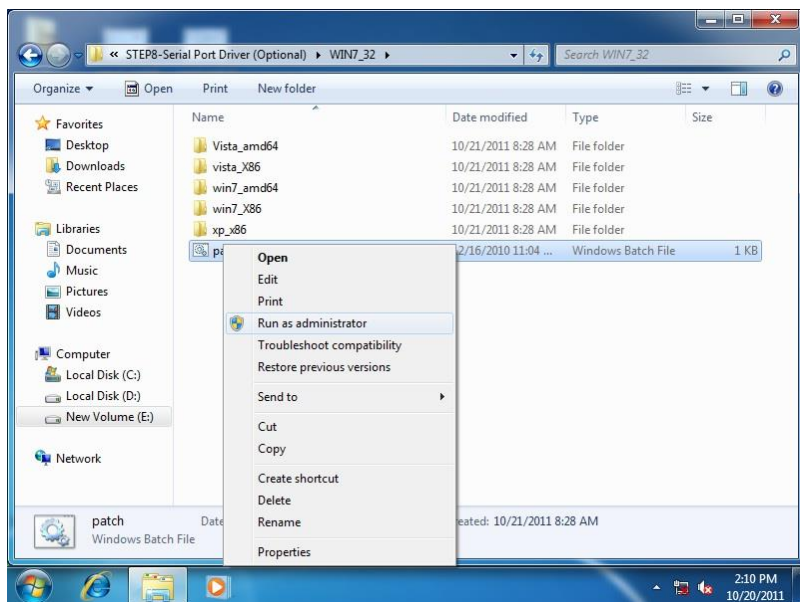

For Windows 8 and Windows 10:

1. Open the **Step 7 - Serial Port Driver (Optional)** folder and select your OS
2. Open the **batch.bat** file in the folder
3. Follow the instructions
4. Drivers will be installed automatically



# Appendix A

---

## Watchdog Timer Programming

## A.1 Watchdog Timer Initial Program

Table 1 : Watch dog relative IO address		
	Default Value	Note
I/O Base Address	0xA10	I/O Base address for Watchdog operation. This address is assigned by SIO LDN7, register 0x60-0x61.

Table 2 : Watchdog relative register table				
Register	Offset	BitNum	Value	Note
Watchdog WDRST# Enable	0x00	7	1	Enable/Disable time out output via WDRST# 0: Disable 1: Enable
Pulse Width	0x05	0:1	01	Width of Pulse signal 00: 1ms (do not use) 01: 25ms 10: 125ms 11: 5s <b><i>Pulse width is must longer then 16ms.</i></b>
Signal Polarity	0x05	2	0	0: low active 1: high active <b><i>Must set this bit to 0</i></b>
Counting Unit	0x05	3	0	Select time unit. 0: second 1: minute
Output Signal Type	0x05	4	1	0: Level 1: Pulse <b><i>Must set this bit to 1</i></b>
Watchdog Timer Enable	0x05	5	1	0: Disable 1: Enable
Timeout Status	0x05	6	1	1: timeout occurred. Write a 1 to clear timeout status
Timer Counter	0x06			Time of watchdog timer (0~255)

## A.2 Watchdog Sample Program

```
*****
// WDT I/O operation relative definition (Please reference to Table 1)
#define WDTAddr    0x510 // WDT I/O base address
Void WDTWriteByte(byte Register, byte Value);
byte WDTReadByte(byte Register);
Void WDTSetReg(byte Register, byte Bit, byte Val);
// Watch Dog relative definition (Please reference to Table 2)
#define DevReg     0x00 // Device configuration register
#define WDRstBit  0x80 // Watchdog WDTRST# (Bit7)
#define WDRstVal  0x80 // Enabled WDTRST#
#define TimerReg   0x05 // Timer register
#define PSWidthBit 0x00 // WDTRST# Pulse width (Bit0:1)
#define PSWidthVal 0x01 // 25ms for WDTRST# pulse
#define PolarityBit 0x02 // WDTRST# Signal polarity (Bit2)
#define PolarityVal 0x00 // Low active for WDTRST#
#define UnitBit    0x03 // Unit for timer (Bit3)
#define ModeBit    0x04 // WDTRST# mode (Bit4)
#define ModeVal    0x01 // 0:level 1: pulse
#define EnableBit  0x05 // WDT timer enable (Bit5)
#define EnableVal  0x01 // 1: enable
#define StatusBit  0x06 // WDT timer status (Bit6)
#define CounterReg 0x06 // Timer counter register
*****

*****
VOID Main(){
    // Procedure : AaeonWDTConfig
    // (byte)Timer : Counter of WDT timer.(0x00~0xFF)
    // (boolean)Unit : Select time unit(0: second, 1: minute).
    AaeonWDTConfig(Counter, Unit);

    // Procedure : AaeonWDTEnable
    // This procedure will enable the WDT counting.
    AaeonWDTEnable();
}
*****

*****
// Procedure : AaeonWDTEnable
```

```

VOID AaeonWDTEnable (){
WDTEnableDisable(1);
}

// Procedure : AaeonWDTConfig
VOID AaeonWDTConfig (byte Counter, BOOLEAN Unit){
// Disable WDT counting
WDTEnableDisable(0);
// Clear Watchdog Timeout Status
WDTClearTimeoutStatus();
// WDT relative parameter setting
WDTParameterSetting(Timer, Unit);
}

VOID WDTEnableDisable(byte Value){
    If (Value == 1)
        WDTSetBit(TimerReg, EnableBit, 1);
    else
        WDTSetBit(TimerReg, EnableBit, 0);
}

VOID WDTParameterSetting(byte Counter, BOOLEAN Unit){
// Watchdog Timer counter setting
WDTWriteByte(CounterReg, Counter);
// WDT counting unit setting
WDTSetBit(TimerReg, UnitBit, Unit);
// WDT output mode set to pulse
WDTSetBit(TimerReg, ModeBit, ModeVal);
// WDT output mode set to active low
WDTSetBit(TimerReg, PolarityBit, PolarityVal);
// WDT output pulse width is 25ms
WDTSetBit(TimerReg, PSWidthBit, PSWidthVal);
// Watchdog WDTRST# Enable
WDTSetBit(DevReg, WDTRstBit, WDTRstVal);
}

VOID WDTClearTimeoutStatus{
    WDTSetBit(TimerReg, StatusBit, 1);
}

*****
*****

```

```
VOID WDTWriteByte(byte Register, byte Value){
    IOWriteByte(WDTAddr+Register, Value);
}

byte WDTReadByte(byte Register){
    return IOReadByte(WDTAddr+Register);
}

VOID WDTSetBit(byte Register, byte Bit, byte Val){
    byte TmpValue;

    TmpValue = WDTReadByte(Register);
    TmpValue &= ~(1 << Bit);
    TmpValue |= Val << Bit;
    WDTWriteByte(Register, TmpValue);
}

*****
```











































# Appendix B

---

I/O Information

## B.1 I/O Address Map

Address Range	Device Name
[0000000000000000 - 000000000000006F]	PCI Express Root Complex
[0000000000000020 - 0000000000000021]	Programmable interrupt controller
[0000000000000024 - 0000000000000025]	Programmable interrupt controller
[0000000000000028 - 0000000000000029]	Programmable interrupt controller
[000000000000002C - 000000000000002D]	Programmable interrupt controller
[0000000000000030 - 0000000000000031]	Programmable interrupt controller
[0000000000000034 - 0000000000000035]	Programmable interrupt controller
[0000000000000038 - 0000000000000039]	Programmable interrupt controller
[000000000000003C - 000000000000003D]	Programmable interrupt controller
[0000000000000040 - 0000000000000043]	System timer
[000000000000004E - 000000000000004F]	Motherboard resources
[0000000000000050 - 0000000000000053]	System timer
[0000000000000061 - 0000000000000061]	Motherboard resources
[0000000000000063 - 0000000000000063]	Motherboard resources
[0000000000000065 - 0000000000000065]	Motherboard resources
[0000000000000067 - 0000000000000067]	Motherboard resources
[0000000000000070 - 0000000000000070]	Motherboard resources
[0000000000000070 - 0000000000000077]	System CMOS/real time clock
[0000000000000078 - 000000000000007F]	PCI Express Root Complex
[0000000000000080 - 000000000000008F]	Motherboard resources
[0000000000000092 - 0000000000000092]	Motherboard resources
[00000000000000A0 - 00000000000000A1]	Programmable interrupt controller
[00000000000000A4 - 00000000000000A5]	Programmable interrupt controller
[00000000000000A8 - 00000000000000A9]	Programmable interrupt controller
[00000000000000AC - 00000000000000AD]	Programmable interrupt controller
[00000000000000B0 - 00000000000000B1]	Programmable interrupt controller
[00000000000000B2 - 00000000000000B3]	Motherboard resources
[00000000000000B4 - 00000000000000B5]	Programmable interrupt controller
[00000000000000B8 - 00000000000000B9]	Programmable interrupt controller
[00000000000000BC - 00000000000000BD]	Programmable interrupt controller
[00000000000000C0 - 00000000000000C7]	Communications Port (COM6)
[00000000000000D0 - 00000000000000D7]	Communications Port (COM5)
[00000000000000E8 - 00000000000000EF]	Communications Port (COM4)
[00000000000000F8 - 00000000000000FF]	Communications Port (COM2)
[00000000000003B0 - 00000000000003BB]	Intel(R) HD Graphics
[00000000000003C0 - 00000000000003DF]	Intel(R) HD Graphics
[00000000000003E8 - 00000000000003EF]	Communications Port (COM3)
[00000000000003F8 - 00000000000003FF]	Communications Port (COM1)
[0000000000000400 - 000000000000047F]	Motherboard resources
[00000000000004D0 - 00000000000004DF]	Programmable interrupt controller
[0000000000000500 - 00000000000005FE]	Motherboard resources

	[000000000000063 - 000000000000063]	Motherboard resources
	[000000000000065 - 000000000000065]	Motherboard resources
	[000000000000067 - 000000000000067]	Motherboard resources
	[000000000000070 - 000000000000070]	Motherboard resources
	[000000000000070 - 000000000000077]	System CMOS/real time clock
	[000000000000078 - 000000000000CF7]	PCI Express Root Complex
	[000000000000080 - 00000000000008F]	Motherboard resources
	[000000000000092 - 000000000000092]	Motherboard resources
	[000000000000A0 - 000000000000A1]	Programmable interrupt controller
	[000000000000A4 - 000000000000A5]	Programmable interrupt controller
	[000000000000A8 - 000000000000A9]	Programmable interrupt controller
	[000000000000AC - 000000000000AD]	Programmable interrupt controller
	[000000000000B0 - 000000000000B1]	Programmable interrupt controller
	[000000000000B2 - 000000000000B3]	Motherboard resources
	[000000000000B4 - 000000000000B5]	Programmable interrupt controller
	[000000000000B8 - 000000000000B9]	Programmable interrupt controller
	[000000000000BC - 000000000000BD]	Programmable interrupt controller
	[000000000000C0 - 000000000000C7]	Communications Port (COM6)
	[000000000000D0 - 000000000000D7]	Communications Port (COM5)
	[000000000000E8 - 000000000000EF]	Communications Port (COM4)
	[000000000000F8 - 000000000000FF]	Communications Port (COM2)
	[0000000000003B0 - 0000000000003BB]	Intel(R) HD Graphics
	[0000000000003C0 - 0000000000003DF]	Intel(R) HD Graphics
	[0000000000003E8 - 0000000000003EF]	Communications Port (COM3)
	[0000000000003F8 - 0000000000003FF]	Communications Port (COM1)
	[000000000000400 - 00000000000047F]	Motherboard resources
	[0000000000004D0 - 0000000000004D1]	Programmable interrupt controller
	[000000000000500 - 0000000000005FE]	Motherboard resources
	[000000000000680 - 00000000000069F]	Motherboard resources
	[000000000000A00 - 000000000000ADF]	Motherboard resources
	[000000000000A10 - 000000000000A1F]	Motherboard resources
	[000000000000A20 - 000000000000A2F]	Motherboard resources
	[000000000000D00 - 000000000000FFF]	PCI Express Root Complex
	[000000000000D00 - 000000000000D0F]	Realtek PCIe GBE Family Controller
	[000000000000D00 - 000000000000DFF]	PCI Express standard Root Port
	[000000000000E00 - 000000000000E0F]	Realtek PCIe GBE Family Controller #2
	[000000000000E00 - 000000000000EFF]	PCI Express standard Root Port
	[000000000000F00 - 000000000000F03F]	Intel(R) HD Graphics
	[000000000000F040 - 000000000000F05F]	Intel(R) Celeron(R)/Pentium(R) SM Bus Controller - 2292
	[000000000000F060 - 000000000000F07F]	Standard SATA AHCI Controller
		Interrupt request (IRQ)
		Memory



## B.2 Memory Address Map

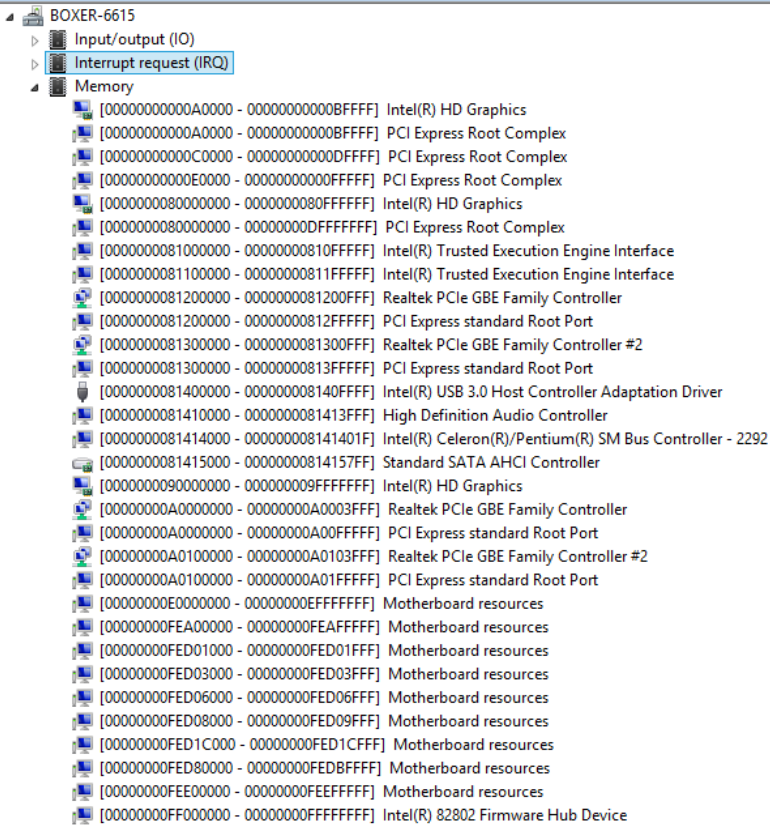

Address Range	Device Name
[0000000000A0000 - 0000000000BFFFF]	Intel(R) HD Graphics
[0000000000A0000 - 0000000000BFFFF]	PCI Express Root Complex
[0000000000C0000 - 0000000000DFFFF]	PCI Express Root Complex
[0000000000E0000 - 0000000000FFFFFF]	PCI Express Root Complex
[0000000080000000 - 0000000080FFFFFF]	Intel(R) HD Graphics
[0000000080000000 - 00000000DFFFFFF]	PCI Express Root Complex
[0000000081000000 - 00000000810FFFF]	Intel(R) Trusted Execution Engine Interface
[0000000081100000 - 00000000811FFFF]	Intel(R) Trusted Execution Engine Interface
[0000000081200000 - 0000000081200FF]	Realtek PCIe GBE Family Controller
[0000000081200000 - 00000000812FFFF]	PCI Express standard Root Port
[0000000081300000 - 0000000081300FF]	Realtek PCIe GBE Family Controller #2
[0000000081300000 - 00000000813FFFF]	PCI Express standard Root Port
[0000000081400000 - 0000000081400FF]	Intel(R) USB 3.0 Host Controller Adaptation Driver
[0000000081410000 - 0000000081413FF]	High Definition Audio Controller
[0000000081414000 - 000000008141401F]	Intel(R) Celeron(R)/Pentium(R) SM Bus Controller - 2292
[0000000081415000 - 00000000814157FF]	Standard SATA AHCI Controller
[0000000090000000 - 000000009FFFFFF]	Intel(R) HD Graphics
[00000000A0000000 - 00000000A0003FFF]	Realtek PCIe GBE Family Controller
[00000000A0000000 - 00000000A000FFFF]	PCI Express standard Root Port
[00000000A0100000 - 00000000A0103FFF]	Realtek PCIe GBE Family Controller #2
[00000000A0100000 - 00000000A010FFFF]	PCI Express standard Root Port
[00000000E0000000 - 00000000EFFFFFF]	Motherboard resources
[00000000FEA00000 - 00000000FEAFFFF]	Motherboard resources
[00000000FED01000 - 00000000FED01FFF]	Motherboard resources
[00000000FED03000 - 00000000FED03FFF]	Motherboard resources
[00000000FED06000 - 00000000FED06FFF]	Motherboard resources
[00000000FED08000 - 00000000FED09FFF]	Motherboard resources
[00000000FED1C000 - 00000000FED1CFFF]	Motherboard resources
[00000000FED80000 - 00000000FEDBFFFF]	Motherboard resources
[00000000FEE00000 - 00000000FEEFFFF]	Motherboard resources
[00000000FF000000 - 00000000FFFFFF]	Intel(R) 82802 Firmware Hub Device

## B.3 IRQ Mapping Chart

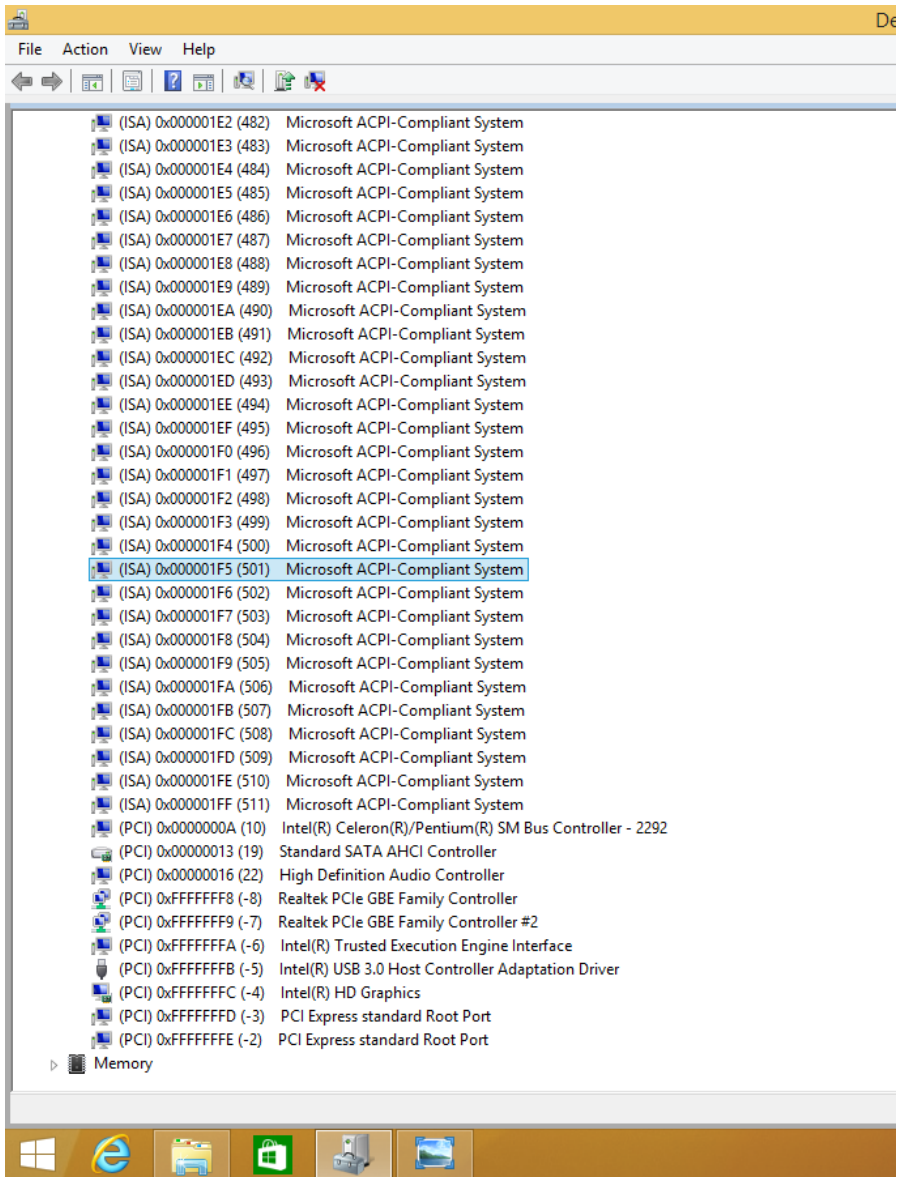

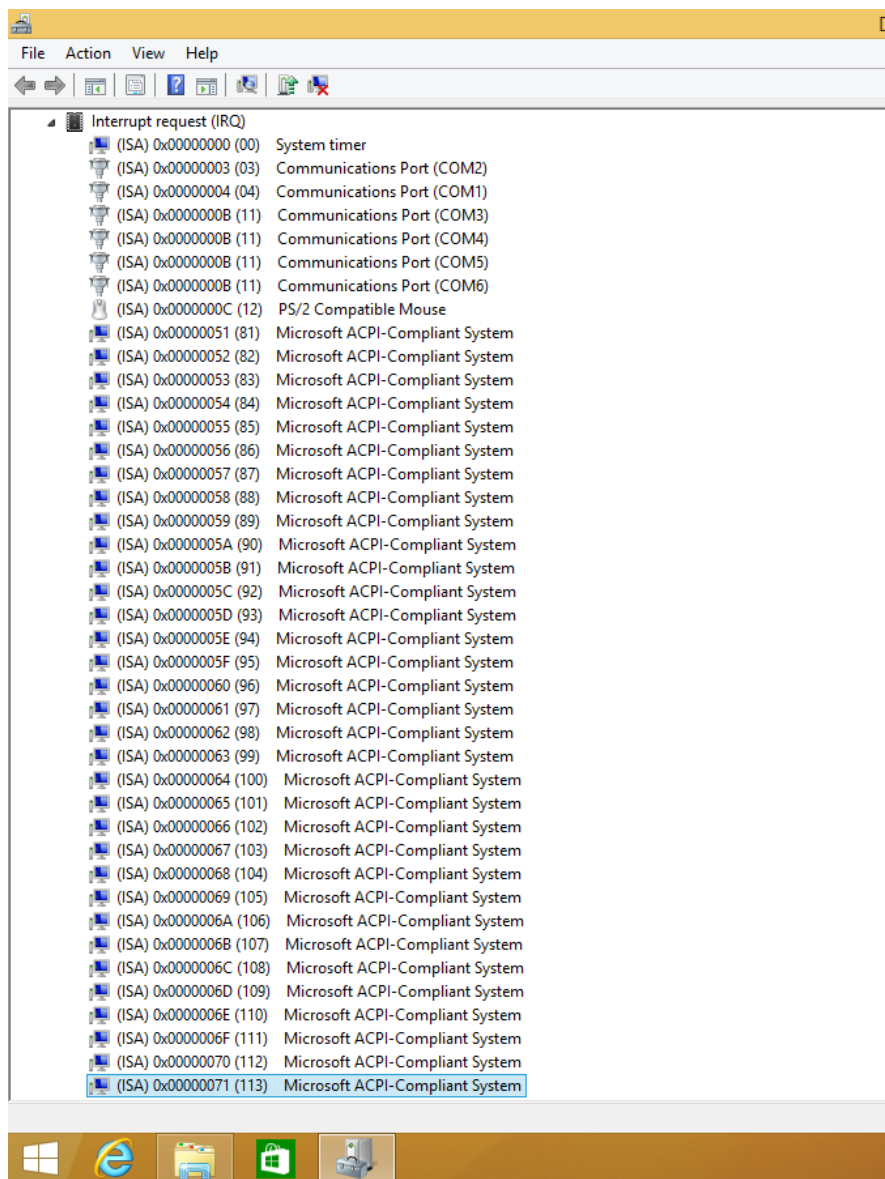

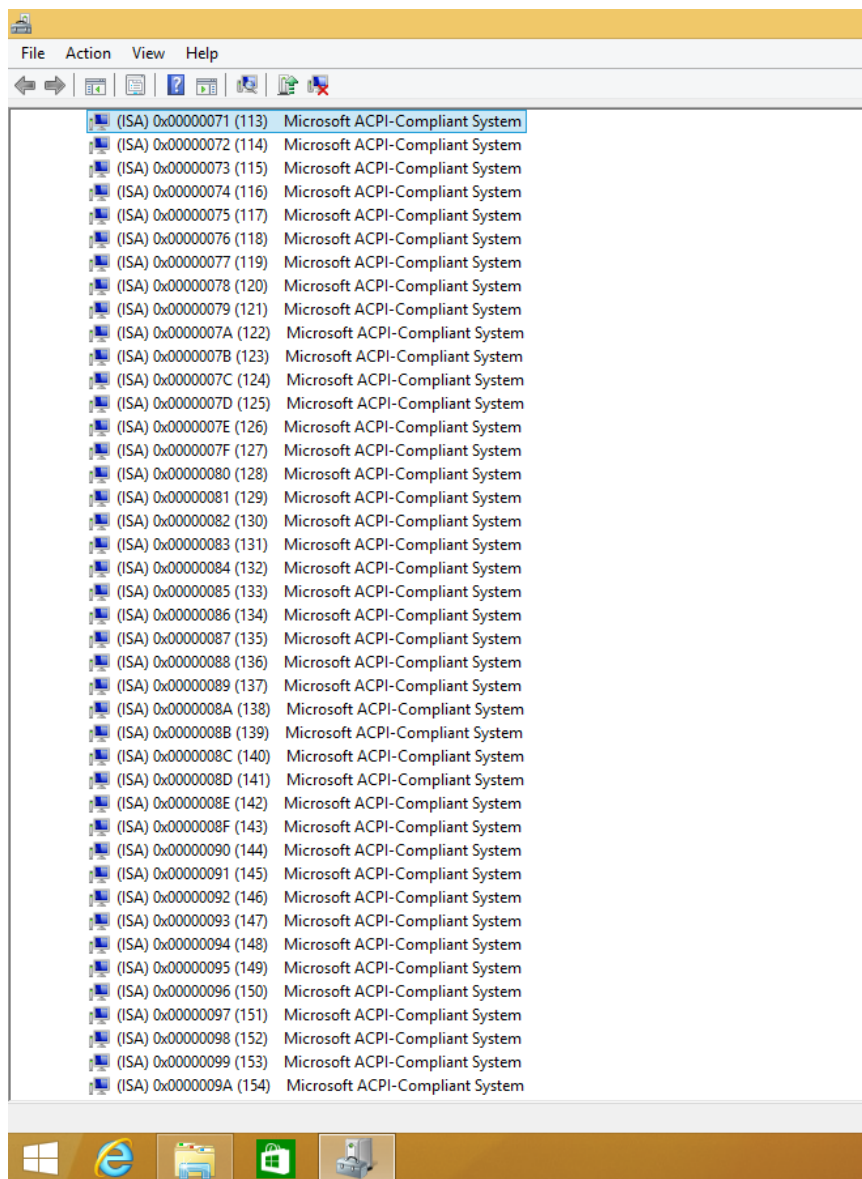

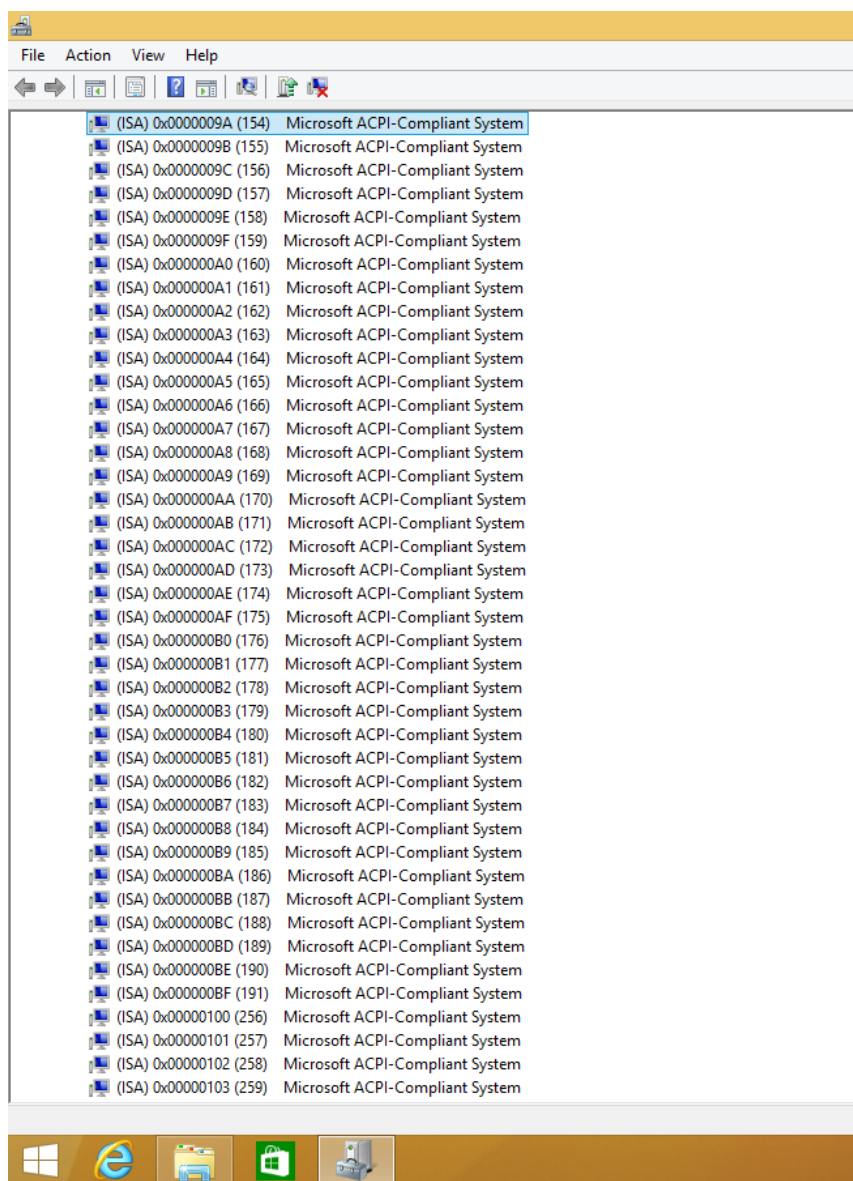

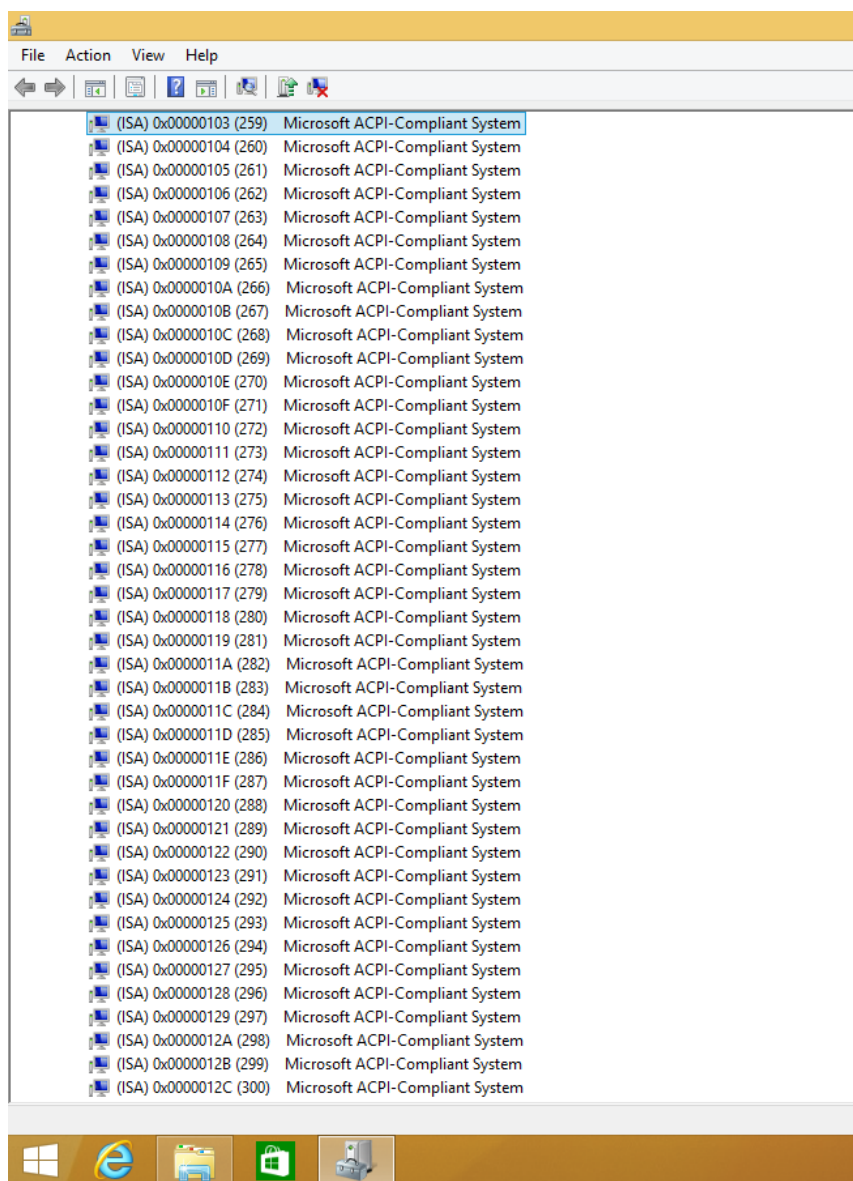

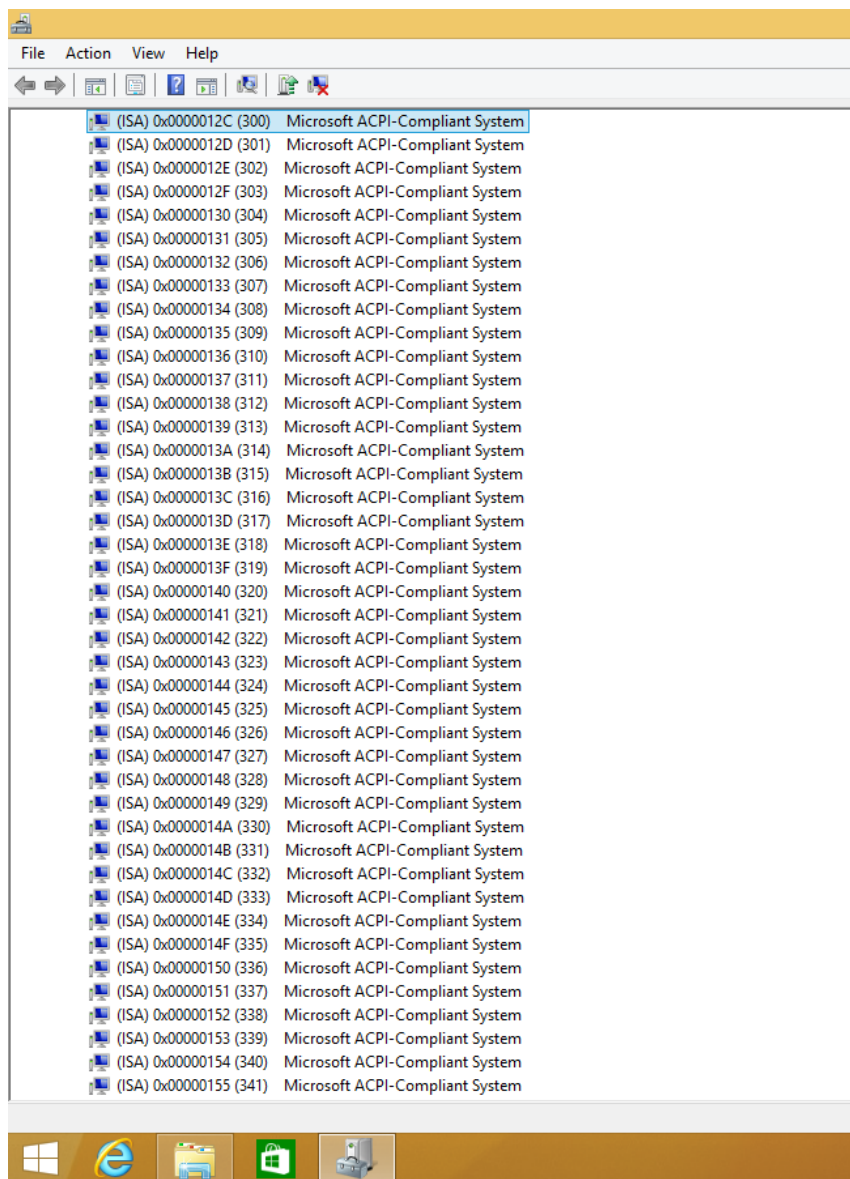



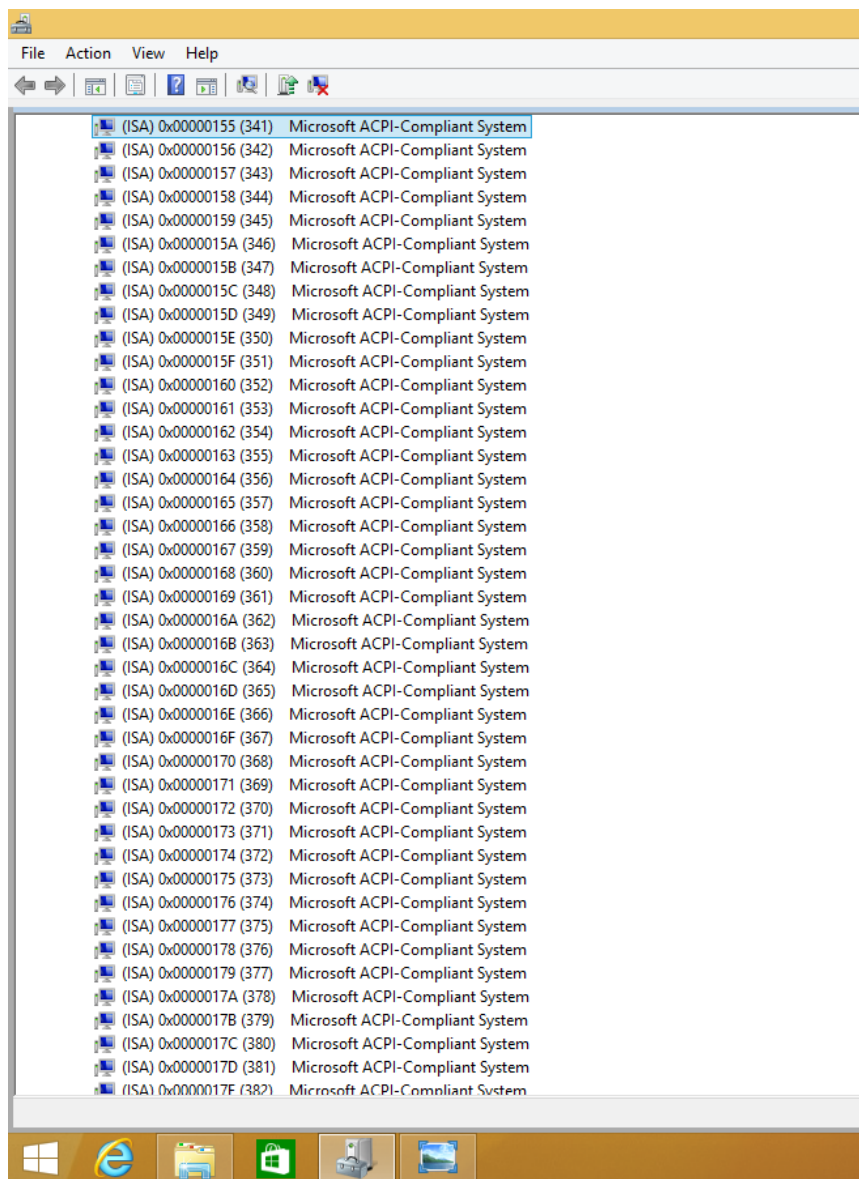



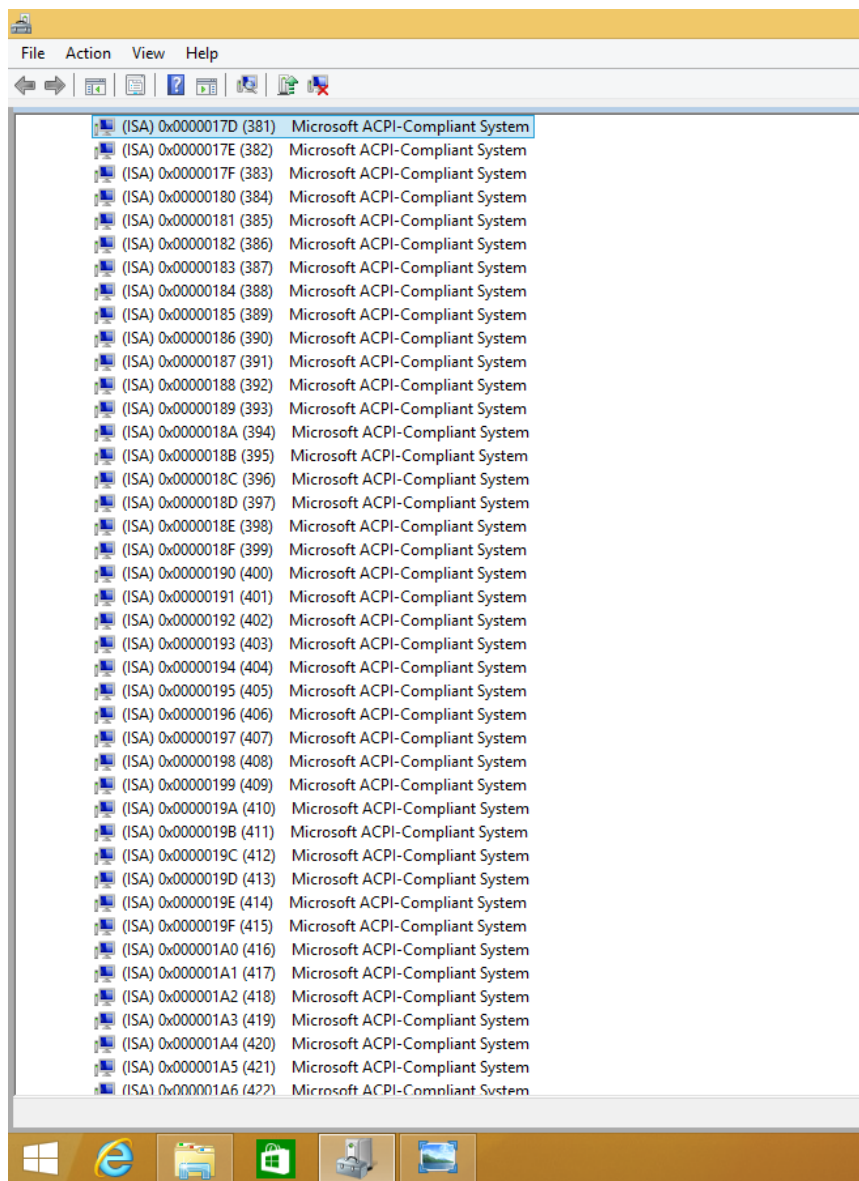



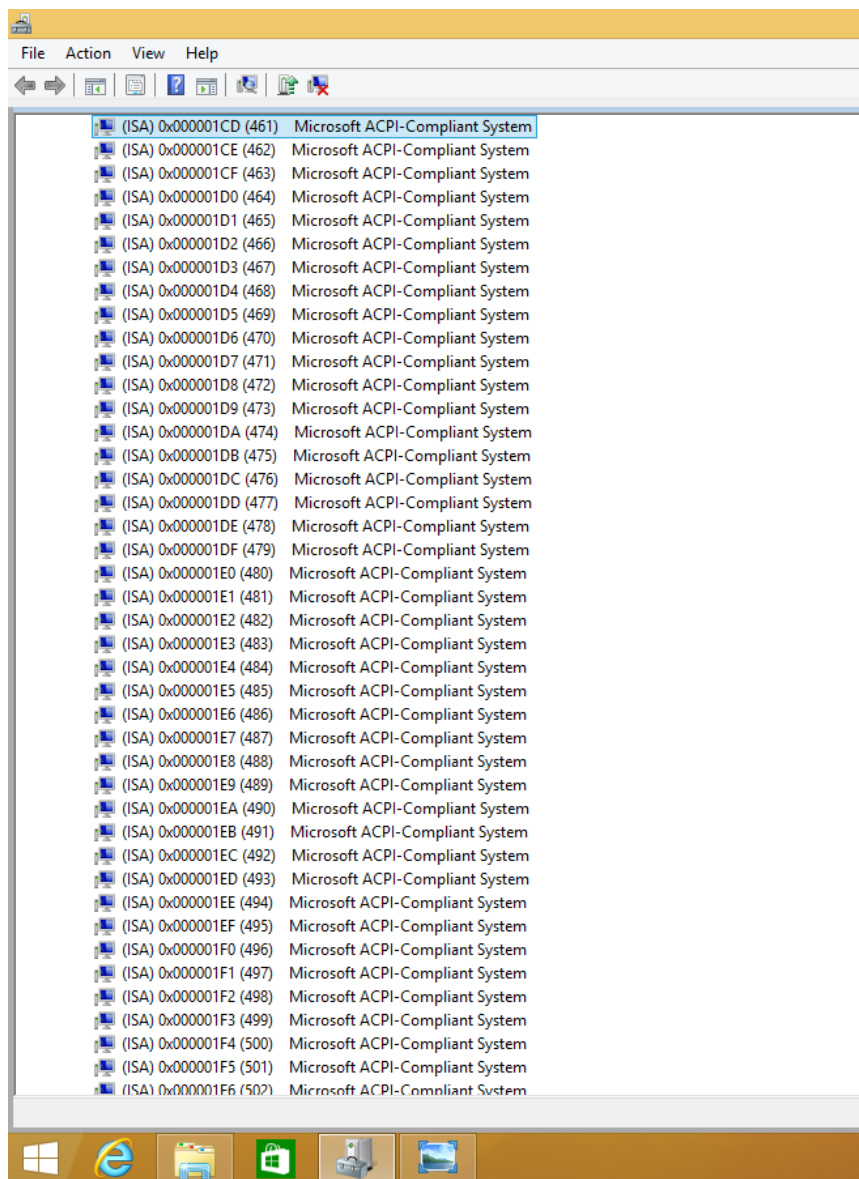

# Appendix C

---

Digital I/O Information

## C.1 Electrical Specifications for Digital I/O Ports

---

Table 1 : Digital Input/Output Pin Electrical Specification

		Input Threshold Voltage		Output Voltage		
		Low	High	Low	High	
DIO0	I/O	0.8	2.0	0	5	
DIO1	I/O	0.8	2.0	0	5	
DIO2	I/O	0.8	2.0	0	5	
DIO3	I/O	0.8	2.0	0	5	
DIO4	I/O	0.8	2.0	0	5	
DIO5	I/O	0.8	2.0	0	5	
DIO6	I/O	0.8	2.0	0	5	
DIO7	I/O	0.8	2.0	0	5	

## C.2 DIO Programming

---

BOXER-6615 utilizes FINTEK F81866D chipset as its Digital I/O controller. Below are the procedures to complete its configuration and the AAEON initial DIO program is also attached based on which you can develop customized program to fit your application. There are three steps to complete the configuration setup: (1) Enter the MB PnP Mode; (2) Modify the data of configuration registers; (3) Exit the MB PnP Mode. Undesired result may occur if the MB PnP Mode is not exited normally.

### C.3 DIO Register

	Default Value	Note
Index	0x2E	SIO MB PnP Mode Index Register 0x2E or 0x4E
Data	0x2F)	SIO MB PnP Mode Data Register 0x2F or 0x4F

	LDN	Register	Bit	Note
GPIO0 Direction	0x06	0x88	0	0:input, 1: output
GPIO1 Direction	0x06	0x88	1	
GPIO2 Direction	0x06	0x88	2	
GPIO3 Direction	0x06	0x88	3	
GPIO4 Direction	0x06	0x88	4	
GPIO5 Direction	0x06	0x88	5	
GPIO6 Direction	0x06	0x88	6	
GPIO7 Direction	0x06	0x88	7	
GPIO0 Output Level	0x06	0x89	0	0:low, 1: high
GPIO1 Output Level	0x06	0x89	1	
GPIO2 Output Level	0x06	0x89	2	
GPIO3 Output Level	0x06	0x89	3	
GPIO4 Output Level	0x06	0x89	4	
GPIO5 Output Level	0x06	0x89	5	
GPIO6 Output Level	0x06	0x89	6	
GPIO7 Output Level	0x06	0x89	7	

GPIO0 Status	0x06	0x8A	0	0:low, 1: high
GPIO1 Status	0x06	0x8A	1	
GPIO2 Status	0x06	0x8A	2	
GPIO3 Status	0x06	0x8A	3	
GPIO4 Status	0x06	0x8A	4	
GPIO5 Status	0x06	0x8A	5	
GPIO6 Status	0x06	0x8A	6	
GPIO7 Status	0x06	0x8A	7	



## C.4 DIO Sample Program

---

```
*****
// SuperIO relative definition (Please reference to Table 2)
#define SIOIndex 0x2E
#define SIOData 0x2F
#define DIOLDN 0x06
IOWriteByte(byte IOPort, byte Value);
IOReadByte(byte IOPort);
// DIO relative definition (Please reference to Table 3)
#define DirReg_L 0x88 // 0:input, 1: output
#define DirReg_H 0x80 // 0:input, 1: output
#define InputPin 0x00
#define OutputPin 0x01
#define OutputReg_L 0x89 // 0:low, 1: high
#define OutputReg_H 0x81 // 0:low, 1: high
#define StatusReg_L 0x8A // 0:low, 1: high
#define StatusReg_H 0x82 // 0:low, 1: high
#define PinLow 0x00
#define PinHigh 0x01
#define Pin0Bit 0x00
#define Pin1Bit 0x01
#define Pin2Bit 0x02
#define Pin3Bit 0x03
#define Pin4Bit 0x04
#define Pin5Bit 0x05
#define Pin6Bit 0x06
#define Pin7Bit 0x07
```

```

*****

*****

VOID  Main(){
    Boolean PinStatus ;

    // Procedure : AaeonReadPinStatus
    // Input :
    //     Example, Read Digital I/O Pin 3 status
// Output :
//     InputStatus :
//         0: Digital I/O Pin level is low
//         1: Digital I/O Pin level is High
    PinStatus = AaeonReadPinStatus(Pin3Bit);

    // Procedure : AaeonSetOutputLevel
    // Input :
    //     Example, Set Digital I/O Pin 2 to high level
    AaeonSetOutputLevel(Pin2Bit, PinHigh);
}

*****

*****

Boolean  AaeonReadPinStatus(byte PinBit){
    Boolean PinStatus ;
    PinStatus = SIOBitRead(DIOLDN, StatusReg_L, PinBit);
    Return PinStatus ;
}

```

```

}

VOID  AaeonSetOutputLevel(byte PinBit, byte Value){
    ConfigDioMode(PinBit, OutputPin);
    SIOBitSet(DIOLDN, OutputReg_L, PinBit, Value);
}

*****

*****VOID

SIOEnterMBPnPMode(){
    IOWriteByte(SIOIndex, 0x87);
    IOWriteByte(SIOIndex, 0x87);
}

VOID  SIOExitMBPnPMode(){
    IOWriteByte(SIOIndex, 0xAA);
}

VOID  SIOSelectLDN(byte LDN){
    IOWriteByte(SIOIndex, 0x07); // SIO LDN Register Offset = 0x07
    IOWriteByte(SIOData, LDN);
}

VOID  SIOBitSet(byte LDN, byte Register, byte BitNum, byte Value){
    Byte TmpValue;

    SIOEnterMBPnPMode();
    SIOSelectLDN(LDN);
    IOWriteByte(SIOIndex, Register);
}

```

```

    TmpValue = IOReadByte(SIOData);
    TmpValue &= ~(1 << BitNum);
    TmpValue |= (Value << BitNum);
    IOWriteByte(SIOData, TmpValue);
    SIOExitMBPnPMode();
}

```

```

VOID  SIOByteSet(byte LDN, byte Register, byte Value){
    SIOEnterMBPnPMode();
    SIOSelectLDN(LDN);
    IOWriteByte(SIOIndex, Register);
    IOWriteByte(SIOData, Value);
    SIOExitMBPnPMode();
}

```

```
*****
```

```
*****
```

```

Boolean  SIOBitRead(byte LDN, byte Register, byte BitNum){
    Byte TmpValue;

    SIOEnterMBPnPMode();
    SIOSelectLDN(LDN);
    IOWriteByte(SIOIndex, Register);
    TmpValue = IOReadByte(SIOData);
    TmpValue &= (1 << BitNum);
    SIOExitMBPnPMode();
    If(TmpValue == 0)
        Return 0;
}

```

```
        Return 1;
    }
VOID  ConfigDioMode(byte PinBit, byte Mode){
    Byte TmpValue;

    SIOEnterMBPnPMode();
    SIOSelectLDN(DIOLDN);
    IOWriteByte(SIOIndex, DirReg_L);
    TmpValue = IOReadByte(SIOData);
    TmpValue |= (Mode << PinBit);
    IOWriteByte(SIOData, DirReg_L);
    SIOExitMBPnPMode();
}
*****
```